

Calvin Klein

2015

trade catalogue watch + jewelry P3



Calvin Klein

Brand introduction	3
Pictograms	4
Calvin Klein novelties watch	5
Calvin Klein core collection watch	32
Calvin Klein novelties jewelry	66
Calvin Klein core collection jewelry	106
Calvin Klein Jeans core collection jewelry	144
Global advertising campaign	151
Introduction	151
Period 1	152
Period 2	155
Merchandising guidelines	159
Display and elements presentation	159
Merchandising in calvin klein furniture	169
Merchandising in generic furniture and general rules	179
Technical specification	181

Calvin Klein

CALVIN KLEIN WATCHES + JEWELRY

Calvin Klein Watch + Jewelry Co. Ltd. is one of the rare ambassadors of the Swiss watch industry in the fashion segment. In 1997, Calvin Klein and the Swatch Group merged their formidable talents to create, what is known as today, Calvin Klein watches + jewelry.

The clean, contemporary, graphic lines of watches such as Calvin Klein dress struck a chord with the public, and the new, inimitable “watch as fashion accessory” was born.

Today, more than 200 different Swiss made designs for both men and women are on the shelves in over 80 nations. Launched in 2004, Calvin Klein jewelry features clean lines and the characteristic curved metal surfaces that make for a sexy but simple design aesthetic.

Calvin Klein Jeans introduces watches and jewelry in 2006. The line of men’s and women’s watches is designed in keeping with the aesthetic of Calvin Klein Jeans, incorporating combinations of brushed stainless steel with denim canvas and vegetal tanned leathers, with jeans wear inspired buckles, straps, and stitching details.

































Calvin Klein, Inc., a wholly owned subsidiary of PVH Corp. is one of the leading fashion design and marketing studios in the world. It designs and markets women’s and men’s designer collection apparel and a range of other products that are manufactured and marketed through an extensive network of licensing agreements and other arrangements worldwide.

Product lines under the various Calvin Klein brands include women’s dresses and suits, men’s dress furnishings and tailored clothing, men’s and women’s sportswear and bridge and collection apparel, golf apparel, jeanswear, underwear, fragrances, eyewear, women’s performance apparel, hosiery, socks, footwear, swimwear, jewelry, watches, outerwear, handbags, small leather goods, and home furnishings (including furniture).

For more information, please visit calvinklein.com.

Calvin Klein

PICTOGRAMS

	quartz movement		polished
	automatic movement		brushed
	mineral glass		polished and brushed
	sapphire glass		sandblasted
	water-resistance up to 3 bar		sandblasted and polished
	water-resistance up to 5 bar		plastic
	water-resistance up to 10 bar		resin
	stainless steel		glass
	SST PVD yellow gold		white enamel
	SST PVD pink gold		black enamel
	SST PVD light grey		white crystal
	SST PVD grey		pink crystal
	SST PVD titan		black crystal
	SST PVD black		diamond
	leather		zirconia
	alligator		
	rubber		
	silicone		
	textile		
	mesh		
	satin		
	silk		
	cotton		

CALVIN KLEIN NOVELTIES WATCH

Calvin Klein round (K5U)	6
Calvin Klein supreme (K6C)	8
Calvin Klein future (K5B)	10
Calvin Klein highline (K5M)	12
Calvin Klein infinite (K5S)	14
Calvin Klein formality (K4M)	15
Calvin Klein mesh (K5L)	16
Calvin Klein spellbound (K5V)	17
Calvin Klein earth (K5Y)	18
Calvin Klein city (K2G)	19
Calvin Klein color (K5E)	20
Calvin Klein simplicity (K43)	22
Calvin Klein city (K2G)	22
Calvin Klein stately (K3G)	23
Calvin Klein lively (K4U)	23
Calvin Klein edge (K5T)	25
Calvin Klein senses (K5N)	26
Calvin Klein alliance (K5R)	28
Calvin Klein infinite (K5S)	30
Calvin Klein microbelt (K5H)	31

Calvin Klein round



K5U2S146 lady small	
EAN	 7 6 1 2 6 3 5 0 9 7 8 8 6
M	ETA 901.001 - HM
D	Silver
C	Ø 32.50 mm
B	18.00 mm / 16.00 mm - Jewelry clasp



K5U2S141 lady small	
EAN	 7 6 1 2 6 3 5 0 9 7 8 6 2
M	ETA 901.001 - HM
D	Black
C	Ø 32.50 mm
B	18.00 mm / 16.00 mm - Jewelry clasp



K5U2S148 lady small	
EAN	 7 6 1 2 6 3 5 0 9 7 9 0 9
M	ETA 901.001 - HM
D	Mirror
C	Ø 32.50 mm
B	18.00 mm / 16.00 mm - Jewelry clasp



K5U2S546 lady small	
EAN	 7 6 1 2 6 3 5 0 9 7 9 2 3
M	ETA 901.001 - HM
D	Silver
C	Ø 32.50 mm
B	18.00 mm / 16.00 mm - Jewelry clasp



K5U2S646 lady small	
EAN	 7 6 1 2 6 3 5 0 9 7 9 4 7
M	ETA 901.001 - HM
D	Silver
C	Ø 32.50 mm
B	18.00 mm / 16.00 mm - Jewelry clasp

Calvin Klein round



K5U2M146 lady medium	
EAN	 7 6 1 2 6 3 5 0 9 7 8 9 3
M	ETA 901.001 - HM
D	Silver
C	Ø 32.50 mm
B	18.00 mm / 16.00 mm - Jewelry clasp



K5U2M141 lady medium	
EAN	 7 6 1 2 6 3 5 0 9 7 8 7 9
M	ETA 901.001 - HM
D	Black
C	Ø 32.50 mm
B	18.00 mm / 16.00 mm - Jewelry clasp



K5U2M148 lady medium	
EAN	 7 6 1 2 6 3 5 0 9 7 9 1 6
M	ETA 901.001 - HM
D	Mirror
C	Ø 32.50 mm
B	18.00 mm / 16.00 mm - Jewelry clasp



K5U2M546 lady medium	
EAN	 7 6 1 2 6 3 5 0 9 7 9 3 0
M	ETA 901.001 - HM
D	Silver
C	Ø 32.50 mm
B	18.00 mm / 16.00 mm - Jewelry clasp



K5U2M646 lady medium	
EAN	 7 6 1 2 6 3 5 0 9 7 9 5 4
M	ETA 901.001 - HM
D	Silver
C	Ø 32.50 mm
B	18.00 mm / 16.00 mm - Jewelry clasp

Calvin Klein supreme



K6C23146 lady	
EAN	 7 6 1 2 6 3 5 0 9 7 7 6 3
M	ETA 802.002 - HM
D	Silver
C	Ø 28.00 mm
B	17.00 mm / 9.00 mm - Butterfly buckle



K6C2X146 lady	
EAN	 7 6 1 2 6 3 5 0 9 7 7 7 0
M	ETA 802.002 - HM
D	Silver
C	Ø 33.00 mm
B	21.00 mm / 12.00 mm - Butterfly buckle



K6C23141 lady	
EAN	 7 6 1 2 6 3 5 0 9 7 7 4 9
M	ETA 802.002 - HM
D	Black
C	Ø 28.00 mm
B	17.00 mm / 9.00 mm - Butterfly buckle



K6C2X141 lady	
EAN	 7 6 1 2 6 3 5 0 9 7 7 5 6
M	ETA 802.002 - HM
D	Black
C	Ø 33.00 mm
B	21.00 mm / 12.00 mm - Butterfly buckle

Calvin Klein supreme



K6C23546 lady	
EAN	 7 6 1 2 6 3 5 0 9 7 7 8 7
M	ETA 802.002 - HM
D	Silver
C	Ø 28.00 mm
B	17.00 mm / 9.00 mm - Butterfly buckle



K6C2X546 lady	
EAN	 7 6 1 2 6 3 5 0 9 7 7 9 4
M	ETA 802.002 - HM
D	Silver
C	Ø 33.00 mm
B	21.00 mm / 12.00 mm - Butterfly buckle



K6C23646 lady	
EAN	 7 6 1 2 6 3 5 0 9 7 8 0 0
M	ETA 802.002 - HM
D	Silver
C	Ø 28.00 mm
B	17.00 mm / 9.00 mm - Butterfly buckle



K6C2X646 lady	
EAN	 7 6 1 2 6 3 5 0 9 7 8 1 7
M	ETA 802.002 - HM
D	Silver
C	Ø 33.00 mm
B	21.00 mm / 12.00 mm - Butterfly buckle

Calvin Klein future



K5B23UM6 lady	
EAN	 7 6 1 2 6 3 5 0 9 8 3 2 6
M	ETA K18401.E02 - HMS CHR date
D	Silver
C	Ø 38.50 mm
B	24.00 mm / 20.00 mm - Pin buckle



K5B23TD1 lady	
EAN	 7 6 1 2 6 3 5 0 9 8 3 1 9
M	ETA K18401.E01 - HMS CHR date
D	Black
C	Ø 38.50 mm
B	24.00 mm / 20.00 mm - Pin buckle



K5B236D1 lady	
EAN	 7 6 1 2 6 3 5 0 9 8 3 3 3
M	ETA K18401.E03 - HMS CHR date
D	Black
C	Ø 38.50 mm
B	24.00 mm / 20.00 mm - Pin buckle



K5B13YC1 lady	
EAN	 7 6 1 2 6 3 5 0 9 8 4 0 1
M	ETA K18401.E01 - HMS CHR date
D	Black
C	Ø 38.50 mm
B	24.00 mm / 20.00 mm - Pin buckle



K5B13XC1 lady	
EAN	 7 6 1 2 6 3 5 0 9 8 3 9 5
M	ETA K18401.E01 - HMS CHR date
D	Black
C	Ø 38.50 mm
B	24.00 mm / 20.00 mm - Pin buckle

Calvin Klein future



K5C21UM6 gent	
EAN	 7 6 1 2 6 3 5 0 9 8 3 4 0
M	ETA K18401.E05 - HMS CHR date
D	Silver
C	□ 39.00 x 39.00 mm
B	26.00 mm / 22.00 mm - Pin buckle



K5C21TD1 gent	
EAN	 7 6 1 2 6 3 5 0 9 8 3 5 7
M	ETA K18401.E04 - HMS CHR date
D	Black
C	□ 39.00 x 39.00 mm
B	26.00 mm / 22.00 mm - Pin buckle



K5C11YC1 gent	
EAN	 7 6 1 2 6 3 5 0 9 8 4 2 5
M	ETA K18401.E04 - HMS CHR date
D	Black
C	□ 39.00 x 39.00 mm
B	26.00 mm / 22.00 mm - Pin buckle



K5C11XC1 gent	
EAN	 7 6 1 2 6 3 5 0 9 8 4 1 8
M	ETA K18401.E04 - HMS CHR date
D	Black
C	□ 39.00 x 39.00 mm
B	26.00 mm / 22.00 mm - Pin buckle



K5C214D1 gent	
EAN	 7 6 1 2 6 3 5 0 9 8 3 6 4
M	ETA K18401.E06 - HMS CHR date
D	Black
C	□ 39.00 x 39.00 mm
B	26.00 mm / 22.00 mm - Pin buckle

Calvin Klein highline



K5M311C6 gent	
EAN	 7 6 1 2 6 3 5 0 9 6 9 7 1
M	ETA F07.101 - HMS
D	Silver
C	Ø 40.00 mm
B	20.00 mm / 20.00 mm - Pin buckle



K5M311C1 gent	
EAN	 7 6 1 2 6 3 5 0 9 6 9 4 0
M	ETA F07.101 - HMS
D	Black
C	Ø 40.00 mm
B	20.00 mm / 20.00 mm - Pin buckle



K5M311VN gent	
EAN	 7 6 1 2 6 3 5 0 9 6 9 9 5
M	ETA F07.101 - HMS
D	Blue
C	Ø 40.00 mm
B	20.00 mm / 20.00 mm - Pin buckle



K5M311D6 gent	
EAN	 7 6 1 2 6 3 5 0 9 6 9 8 8
M	ETA F07.101 - HMS
D	Silver
C	Ø 40.00 mm
B	20.00 mm / 20.00 mm - Pin buckle



K5M311D1 gent	
EAN	 7 6 1 2 6 3 5 0 9 6 9 6 4
M	ETA F07.101 - HMS
D	Black
C	Ø 40.00 mm
B	20.00 mm / 20.00 mm - Pin buckle



K5M311ZN gent	
EAN	 7 6 1 2 6 3 5 0 9 7 0 0 8
M	ETA F07.101 - HMS
D	Blue
C	Ø 40.00 mm
B	20.00 mm / 20.00 mm - Pin buckle

Calvin Klein highline



K5M314C1 gent	
EAN	 7 612635 097015
M	ETA F07.101 - HMS
D	Black
C	Ø 40.00 mm
B	20.00 mm / 20.00 mm - Pin buckle



K5M314D1 gent	
EAN	 7 612635 097022
M	ETA F07.101 - HMS
D	Black
C	Ø 40.00 mm
B	20.00 mm / 20.00 mm - Pin buckle



K5M3X1D6 gent	
EAN	 7 612635 097046
M	ETA F07.111 - HMS
D	Silver
C	Ø 43.00 mm
B	22.00 mm / 20.00 mm - Pin buckle



K5M3X1D1 gent	
EAN	 7 612635 097039
M	ETA F07.111 - HMS
D	Black
C	Ø 43.00 mm
B	22.00 mm / 20.00 mm - Pin buckle



K5M3X4D1 gent	
EAN	 7 612635 097053
M	ETA F07.111 - HMS
D	Black
C	Ø 43.00 mm
B	22.00 mm / 20.00 mm - Pin buckle

Calvin Klein infinite



K5S311C6 gent	
EAN	7 612635 097169
M	ETA F07.111 - HMS date at 3h.
D	Silver
C	Ø 42.00 mm
B	22.00 mm / 20.00 mm - Pin buckle



K5S311C1 gent	
EAN	7 612635 097152
M	ETA F07.111 - HMS date at 3h.
D	Black
C	Ø 42.00 mm
B	22.00 mm / 20.00 mm - Pin buckle



K5S316C3 gent	
EAN	7 612635 097176
M	ETA F07.111 - HMS date at 3h.
D	Cool grey
C	Ø 42.00 mm
B	22.00 mm / 20.00 mm - Pin buckle



K5S31146 gent	
EAN	7 612635 097138
M	ETA F07.111 - HMS date at 3h.
D	Silver
C	Ø 42.00 mm
B	22.00 mm / 19.00 mm - Butterfly buckle



K5S31141 gent	
EAN	7 612635 097121
M	ETA F07.111 - HMS date at 3h.
D	Black
C	Ø 42.00 mm
B	22.00 mm / 19.00 mm - Butterfly buckle



K5S3114N gent	
EAN	7 612635 097145
M	ETA F07.111 - HMS date at 3h.
D	Blue
C	Ø 42.00 mm
B	22.00 mm / 19.00 mm - Butterfly buckle

Calvin Klein formality



K4M271C6 gent chronograph	
EAN	 7 612635 087115
M	ETA G10.211 - HMS CHR date at 4h.
D	Silver
C	Ø 43.50 mm
B	22.00 mm / 20.00 mm - Butterfly buckle



K4M271C3 gent chronograph	
EAN	 7 612635 087108
M	ETA G10.211 - HMS CHR date at 4h.
D	Cool grey
C	Ø 43.50 mm
B	22.00 mm / 20.00 mm - Butterfly buckle



K4M275C6 gent chronograph	
EAN	 7 612635 087146
M	ETA G10.211 - HMS CHR date at 4h.
D	Silver
C	Ø 43.50 mm
B	22.00 mm / 20.00 mm - Butterfly buckle



K4M276C3 gent chronograph	
EAN	 7 612635 087153
M	ETA G10.211 - HMS CHR date at 4h.
D	Cool grey
C	Ø 43.50 mm
B	22.00 mm / 20.00 mm - Butterfly buckle



K4M27146 gent chronograph	
EAN	 7 612635 087139
M	ETA G10.211 - HMS CHR date at 4h.
D	Silver
C	Ø 43.50 mm
B	22.00 mm / 19.00 mm - Butterfly buckle



K4M27143 gent chronograph	
EAN	 7 612635 087122
M	ETA G10.211 - HMS CHR date at 4h.
D	Cool grey
C	Ø 43.50 mm
B	22.00 mm / 19.00 mm - Butterfly buckle

Calvin Klein mesh



K5L13136 lady	
EAN	 7 6 1 2 6 3 5 0 9 3 8 2 6
M	ETA 901.001 - HM
D	Silver
C	□ 22.00 x 27.00 mm
B	28.00 mm / 26.00 mm - Sliding buckle



K5L13131 lady	
EAN	 7 6 1 2 6 3 5 0 9 3 8 1 9
M	ETA 901.001 - HM
D	Black
C	□ 22.00 x 27.00 mm
B	28.00 mm / 26.00 mm - Sliding buckle



K5L13536 lady	
EAN	 7 6 1 2 6 3 5 0 9 3 7 9 6
M	ETA 901.001 - HM
D	Silver
C	□ 22.00 x 27.00 mm
B	28.00 mm / 26.00 mm - Sliding buckle



K5L13636 lady	
EAN	 7 6 1 2 6 3 5 0 9 3 8 0 2
M	ETA 901.001 - HM
D	Silver
C	□ 22.00 x 27.00 mm
B	28.00 mm / 26.00 mm - Sliding buckle

Calvin Klein spellbound



K5V23116 lady	
EAN	 7 6 1 2 6 3 5 0 9 4 9 5 3
M	ETA F03.111 - HM
D	Silver
C	Ø 39.00 mm
B	39.00 mm / 20.00 mm - Pin buckle



K5V231Q4 lady	
EAN	 7 6 1 2 6 3 5 0 9 4 9 8 4
M	ETA F03.111 - HM
D	Grey
C	Ø 39.00 mm
B	39.00 mm / 20.00 mm - Pin buckle



K5V231C6 lady	
EAN	 7 6 1 2 6 3 5 0 9 4 9 4 6
M	ETA F03.111 - HM
D	Silver
C	Ø 39.00 mm
B	39.00 mm / 20.00 mm - Pin buckle



K5V231Z6 lady	
EAN	 7 6 1 2 6 3 5 0 9 4 9 7 7
M	ETA F03.111 - HM
D	Silver
C	Ø 39.00 mm
B	39.00 mm / 20.00 mm - Pin buckle



K5V231V6 lady	
EAN	 7 6 1 2 6 3 5 0 9 4 9 6 0
M	ETA F03.111 - HM
D	Silver
C	Ø 39.00 mm
B	39.00 mm / 20.00 mm - Pin buckle



K5V236C1 lady	
EAN	 7 6 1 2 6 3 5 0 9 4 9 9 1
M	ETA F03.111 - HM
D	Black
C	Ø 39.00 mm
B	39.00 mm / 20.00 mm - Pin buckle

Calvin Klein earth



K5Y31VK6 gent	
EAN	 7 6 1 2 6 3 5 0 9 4 8 6 1
M	ETA F06.161 - HMS date at 3h.
D	Silver
C	Ø 44.20 mm
B	22.00 mm / 20.00 mm - Pin buckle



K5Y31UVN gent	
EAN	 7 6 1 2 6 3 5 0 9 4 8 5 4
M	ETA F06.161 - HMS date at 3h.
D	Blue
C	Ø 44.20 mm
B	22.00 mm / 20.00 mm - Pin buckle



K5Y31TB1 gent	
EAN	 7 6 1 2 6 3 5 0 9 4 8 4 7
M	ETA F06.161 - HMS date at 3h.
D	Black
C	Ø 44.20 mm
B	22.00 mm / 20.00 mm - Pin buckle



K5Y31XWL gent	
EAN	 7 6 1 2 6 3 5 0 9 4 8 7 8
M	ETA F06.161 - HMS date at 3h.
D	Khaki
C	Ø 44.20 mm
B	22.00 mm / 20.00 mm - Pin buckle



K5Y31ZB1 gent	
EAN	 7 6 1 2 6 3 5 0 9 4 8 9 2
M	ETA F06.161 - HMS date at 3h.
D	Black
C	Ø 44.20 mm
B	22.00 mm / 20.00 mm - Pin buckle



K5Y31YB1 gent	
EAN	 7 6 1 2 6 3 5 0 9 4 8 8 5
M	ETA F06.161 - HMS date at 3h.
D	Black
C	Ø 44.20 mm
B	22.00 mm / 20.00 mm - Pin buckle

Calvin Klein city



K2G211WL gent	
EAN	 7 612635 096568
M	ETA F05.111 - HM
D	Khaki
C	Ø 43.00 mm
B	22.00 mm / 20.00 mm - Pin buckle



K2G211Q4 gent	
EAN	 7 612635 094816
M	ETA F05.111 - HM
D	Grey
C	Ø 43.00 mm
B	22.00 mm / 20.00 mm - Pin buckle



K2G211C1 gent	
EAN	 7 612635 094793
M	ETA F05.111 - HM
D	Black
C	Ø 43.00 mm
B	22.00 mm / 20.00 mm - Pin buckle



K2G211GK gent	
EAN	 7 612635 095103
M	ETA F05.111 - HM
D	Brown
C	Ø 43.00 mm
B	22.00 mm / 20.00 mm - Pin buckle



K2G271Q4 gent chronograph	
EAN	 7 612635 094830
M	ETA G10.211 - HMS CHR date at 4h.
D	Grey
C	Ø 43.00 mm
B	22.00 mm / 20.00 mm - Pin buckle



K2G271C1 gent chronograph	
EAN	 7 612635 094823
M	ETA G10.211 - HMS CHR date at 4h.
D	Black
C	Ø 43.00 mm
B	22.00 mm / 20.00 mm - Pin buckle

Calvin Klein color



K5E51FK6 gent	
EAN	 7 612635 095042
M	ETA 802.102 - HMS
D	Silver
C	Ø 40.00 mm
B	20.00 mm / 20.00 mm - Pin buckle



K5E51FW6 gent	
EAN	 7 612635 096704
M	ETA 802.102 - HMS
D	Silver
C	Ø 40.00 mm
B	20.00 mm / 20.00 mm - Pin buckle



K5E51FV4 gent	
EAN	 7 612635 095059
M	ETA 802.102 - HMS
D	Grey
C	Ø 40.00 mm
B	20.00 mm / 20.00 mm - Pin buckle

Calvin Klein color



K5E51GVN gent	
EAN	 7 612635 095073
M	ETA 802.102 - HMS
D	Blue
C	Ø 40.00 mm
B	20.00 mm / 20.00 mm - Pin buckle



K5E51TBX gent	
EAN	 7 612635 096711
M	ETA 802.102 - HMS
D	Black
C	Ø 40.00 mm
B	20.00 mm / 20.00 mm - Pin buckle



K5E51TB1 gent	
EAN	 7 612635 095028
M	ETA 802.102 - HMS
D	Black
C	Ø 40.00 mm
B	20.00 mm / 20.00 mm - Pin buckle

Calvin Klein simplicity



K4323148 lady	
EAN	 7 6 1 2 6 3 5 0 9 4 7 2 4
M	ETA 901.001 - HM
D	Mirror
C	Ø 28.00 mm
B	13.00 mm / 12.00 mm - Push button



K432314E lady	
EAN	 7 6 1 2 6 3 5 0 9 4 7 4 8
M	ETA 901.001 - HM
D	MOP Pink
C	Ø 28.00 mm
B	13.00 mm / 12.00 mm - Push button



K432314N lady	
EAN	 7 6 1 2 6 3 5 0 9 4 7 3 1
M	ETA 901.001 - HM
D	MOP Light blue
C	Ø 28.00 mm
B	13.00 mm / 12.00 mm - Push button



K2G23148 lady	
EAN	 7 6 1 2 6 3 5 0 9 5 1 2 7
M	ETA F05.111 - HM
D	Mirror
C	Ø 30.90 mm
B	16.00 mm / 16.00 mm - Butterfly buckle



K2G2314E lady	
EAN	 7 6 1 2 6 3 5 0 9 5 1 4 1
M	ETA F05.111 - HM
D	MOP Pink
C	Ø 30.90 mm
B	16.00 mm / 16.00 mm - Butterfly buckle



K2G2314X lady	
EAN	 7 6 1 2 6 3 5 0 9 5 1 3 4
M	ETA F05.111 - HM
D	MOP Light blue
C	Ø 30.90 mm
B	16.00 mm / 16.00 mm - Butterfly buckle

Calvin Klein stately



K3G23128 lady	
EAN	 7 6 1 2 6 3 5 0 9 4 6 9 4
M	ETA 901.001 - HM
D	Mirror
C	Ø 33.50 mm
B	16.00 mm / 16.00 mm - Jewelry clasp



K3G2312E lady	
EAN	 7 6 1 2 6 3 5 0 9 4 7 1 7
M	ETA 901.001 - HM
D	MOP Pink
C	Ø 33.50 mm
B	16.00 mm / 16.00 mm - Jewelry clasp



K3G2312N lady	
EAN	 7 6 1 2 6 3 5 0 9 4 7 0 0
M	ETA 901.001 - HM
D	MOP Light blue
C	Ø 33.50 mm
B	16.00 mm / 16.00 mm - Jewelry clasp



K4U23526 lady	
EAN	 7 6 1 2 6 3 5 0 9 4 3 6 6
M	ETA 802.002 - HM
D	Silver
C	Ø 34.00 mm
B	10.50 mm / 5.50 mm - Butterfly buckle



K4U23626 lady	
EAN	 7 6 1 2 6 3 5 0 9 4 3 7 3
M	ETA 802.002 - HM
D	Silver
C	Ø 34.00 mm
B	10.50 mm / 5.50 mm - Butterfly buckle

Calvin Klein lively



K4U236K6 lady	
EAN	 7 6 1 2 6 3 5 0 9 6 5 5 1
M	ETA 802.002 - HM
D	Silver
C	Ø 34.00 mm
B	10.50 mm / 6.00 mm - Pin buckle



K4U236XE lady	
EAN	 7 6 1 2 6 3 5 0 9 5 4 5 5
M	ETA 802.002 - HM
D	MOP Beige
C	Ø 34.00 mm
B	10.50 mm / 6.00 mm - Pin buckle



K4U236FK lady	
EAN	 7 6 1 2 6 3 5 0 9 6 5 9 9
M	ETA 802.002 - HM
D	MOP Brown
C	Ø 34.00 mm
B	10.50 mm / 6.00 mm - Pin buckle



K4U231YM lady	
EAN	 7 6 1 2 6 3 5 0 9 6 4 3 8
M	ETA 802.002 - HM
D	Orange
C	Ø 34.00 mm
B	10.50 mm / 6.00 mm - Pin buckle



K4U231WL lady	
EAN	 7 6 1 2 6 3 5 0 9 5 4 4 8
M	ETA 802.002 - HM
D	Khaki
C	Ø 34.00 mm
B	10.50 mm / 6.00 mm - Pin buckle



K4U231VX lady	
EAN	 7 6 1 2 6 3 5 0 9 5 4 2 4
M	ETA 802.002 - HM
D	light blue
C	Ø 34.00 mm
B	10.50 mm / 6.00 mm - Pin buckle

Calvin Klein edge



K5T33146 lady	
EAN	 7 6 1 2 6 3 5 0 9 3 2 3 9
M	ETA 802.002 - HM
D	Silver
C	Ø 30.00 mm
B	16.00 mm / 16.00 mm - Butterfly buckle



K5T33141 lady	
EAN	 7 6 1 2 6 3 5 0 9 3 2 1 5
M	ETA 802.002 - HM
D	Black
C	Ø 30.00 mm
B	16.00 mm / 16.00 mm - Butterfly buckle



K5T33BZ6 lady	
EAN	 7 6 1 2 6 3 5 0 9 3 2 8 4
M	ETA 802.002 - HM
D	Silver
C	Ø 30.00 mm
B	16.00 mm / 16.00 mm - Butterfly buckle



K5T33C41 lady	
EAN	 7 6 1 2 6 3 5 0 9 3 2 4 6
M	ETA 802.002 - HM
D	Black
C	Ø 30.00 mm
B	16.00 mm / 16.00 mm - Butterfly buckle



K5T33T4N lady	
EAN	 7 6 1 2 6 3 5 0 9 4 2 1 2
M	ETA 802.002 - HM
D	Blue
C	Ø 30.00 mm
B	16.00 mm / 16.00 mm - Butterfly buckle

Calvin Klein senses



K5N2S126 lady small	
EAN	 7 6 1 2 6 3 5 0 9 3 3 2 1
M	ETA 802.002 - HM
D	Silver
C	Ø 27.00 mm



K5N2S121 lady small	
EAN	 7 6 1 2 6 3 5 0 9 3 2 9 1
M	ETA 802.002 - HM
D	Black
C	Ø 27.00 mm



K5N2S1Y6 lady small	
EAN	 7 6 1 2 6 3 5 0 9 3 7 7 2
M	ETA 802.002 - HM
D	Silver
C	Ø 27.00 mm



K5N2S526 lady small	
EAN	 7 6 1 2 6 3 5 0 9 3 8 6 4
M	ETA 802.002 - HM
D	Silver
C	Ø 27.00 mm



K5N2S1Z6 lady small	
EAN	 7 6 1 2 6 3 5 0 9 3 3 4 5
M	ETA 802.002 - HM
D	Silver
C	Ø 27.00 mm



K5N2S626 lady small	
EAN	 7 6 1 2 6 3 5 0 9 3 8 4 0
M	ETA 802.002 - HM
D	Silver
C	Ø 27.00 mm

Calvin Klein senses



K5N2M126 lady medium	
EAN	7 6 1 2 6 3 5 0 9 3 3 3 8
M	ETA 802.002 - HM
D	Silver
C	Ø 27.00 mm



K5N2M121 lady medium	
EAN	7 6 1 2 6 3 5 0 9 3 3 1 4
M	ETA 802.002 - HM
D	Black
C	Ø 27.00 mm



K5N2M1Y6 lady medium	
EAN	7 6 1 2 6 3 5 0 9 3 7 8 9
M	ETA 802.002 - HM
D	Silver
C	Ø 27.00 mm



K5N2M526 lady medium	
EAN	7 6 1 2 6 3 5 0 9 3 8 8 8
M	ETA 802.002 - HM
D	Silver
C	Ø 27.00 mm



K5N2M1Z6 lady medium	
EAN	7 6 1 2 6 3 5 0 9 3 3 5 2
M	ETA 802.002 - HM
D	Silver
C	Ø 27.00 mm



K5N2M626 lady medium	
EAN	7 6 1 2 6 3 5 0 9 3 8 5 7
M	ETA 802.002 - HM
D	Silver
C	Ø 27.00 mm

Calvin Klein alliance



K5R33B4G lady	
EAN	 7 612635 093161
M	ETA F04.111 - HMS date at 3h.
D	MOP White
C	Ø 30.00 mm
B	16.00 mm / 14.00 mm - Butterfly buckle



K5R33B4H lady	
EAN	 7 612635 093154
M	ETA F04.111 - HMS date at 3h.
D	MOP Beige
C	Ø 30.00 mm
B	16.00 mm / 14.00 mm - Butterfly buckle



K5R33B4X lady	
EAN	 7 612635 093697
M	ETA F04.111 - HMS date at 3h.
D	MOP Light blue
C	Ø 30.00 mm
B	16.00 mm / 14.00 mm - Butterfly buckle



K5R33B4Y lady	
EAN	 7 612635 093703
M	ETA F04.111 - HMS date at 3h.
D	MOP Dark grey
C	Ø 30.00 mm
B	16.00 mm / 14.00 mm - Butterfly buckle

Calvin Klein alliance



K5R31146 gent	
EAN	 7 612635 093185
M	ETA F07.111 - HMS date at 3h.
D	Silver
C	Ø 40.00 mm
B	20.00 mm / 18.00 mm - Butterfly buckle



K5R31141 gent	
EAN	 7 612635 093178
M	ETA F07.111 - HMS date at 3h.
D	Black
C	Ø 40.00 mm
B	20.00 mm / 18.00 mm - Butterfly buckle



K5R37146 gent chronograph	
EAN	 7 612635 093208
M	ETA G10.211 - HMS CHR date at 4h.
D	Silver
C	Ø 42.00 mm
B	22.00 mm / 19.00 mm - Butterfly buckle



K5R31B46 gent	
EAN	 7 612635 092911
M	ETA F07.111 - HMS date at 3h.
D	Silver
C	Ø 40.00 mm
B	20.00 mm / 18.00 mm - Butterfly buckle



K5R31B41 gent	
EAN	 7 612635 092904
M	ETA F07.111 - HMS date at 3h.
D	Black
C	Ø 40.00 mm
B	20.00 mm / 18.00 mm - Butterfly buckle



K5R37141 gent chronograph	
EAN	 7 612635 093192
M	ETA G10.211 - HMS CHR date at 4h.
D	Black
C	Ø 42.00 mm
B	22.00 mm / 19.00 mm - Butterfly buckle

Calvin Klein infinite



K5S341C6 gent	
EAN	 7 6 1 2 6 3 5 0 9 2 9 9 7
M	ETA 2824-2 - HMS date at 3h.
D	Silver
C	Ø 42.00 mm
B	22.00 mm / 20.00 mm - Butterfly buckle



K5S341C1 gent	
EAN	 7 6 1 2 6 3 5 0 9 2 9 7 3
M	ETA 2824-2 - HMS date at 3h.
D	Black
C	Ø 42.00 mm
B	22.00 mm / 20.00 mm - Butterfly buckle





K5S34146 gent	
EAN	 7 6 1 2 6 3 5 0 9 2 9 8 0
M	ETA 2824-2 - HMS date at 3h.
D	Silver
C	Ø 42.00 mm
B	22.00 mm / 19.00 mm - Butterfly buckle





K5S34141 gent	
EAN	 7 6 1 2 6 3 5 0 9 2 9 6 6
M	ETA 2824-2 - HMS date at 3h.
D	Black
C	Ø 42.00 mm
B	22.00 mm / 19.00 mm - Butterfly buckle

Calvin Klein microbelt





K5H231K6 lady	
EAN	 7 6 1 2 6 3 5 0 9 2 2 8 7
M	ETA 802.002 - HM
D	Silver
C	 27.50 x 48.55 mm
B	10.00 mm / 10.00 mm - Pin buckle





K5H231B1 lady	
EAN	 7 6 1 2 6 3 5 0 9 2 2 7 0
M	ETA 802.002 - HM
D	Black
C	 27.50 x 48.55 mm
B	10.00 mm / 10.00 mm - Pin buckle





K5H236X6 lady	
EAN	 7 6 1 2 6 3 5 0 9 2 2 9 4
M	ETA 802.002 - HM
D	Silver
C	 27.50 x 48.55 mm
B	10.00 mm / 10.00 mm - Pin buckle



K5H23121 lady	
EAN	 7 6 1 2 6 3 5 0 9 2 2 5 6
M	ETA 802.002 - HM
D	Black
C	 27.50 x 48.55 mm
B	10.00 mm / 10.00 mm - Pin buckle



K5H23126 lady	
EAN	 7 6 1 2 6 3 5 0 9 2 2 6 3
M	ETA 802.002 - HM
D	Silver
C	 27.50 x 48.55 mm
B	10.00 mm / 10.00 mm - Pin buckle

CALVIN KLEIN CORE COLLECTION WATCH

Calvin Klein body (K4G)	34
Calvin Klein impetuous (K4F)	35
Calvin Klein impulsive (K3T)	36
Calvin Klein equal (K3E)	37
Calvin Klein formality (K4M)	38
Calvin Klein subtle (K0V)	39
Calvin Klein glam (K94)	39
Calvin Klein lively (K4U)	40
Calvin Klein amaze (K5D)	41
Calvin Klein time (K4N)	42
Calvin Klein district (K0Q)	44
Calvin Klein bold (K5A)	44
Calvin Klein stately (K3G)	46
Calvin Klein simplicity (K43)	47
Calvin Klein city (K2G)	48
Calvin Klein eager (K4B)	53
Calvin Klein classic (K4D)	54
Calvin Klein accent (K2Y)	57
Calvin Klein minimal (K3M)	58
Calvin Klein postminimal (K76)	60
Calvin Klein sight (K1S)	61
Calvin Klein delight (K1A)	62
Calvin Klein suspension (K33)	63
Calvin Klein graceful (K1P)	63
Calvin Klein incentive (K3P)	64
Calvin Klein firm (K3N)	64
Calvin Klein mirror (K28)	65

Calvin Klein
swiss made

Calvin Klein body



K4G23126 lady	
EAN	 7 6 1 2 6 3 5 0 8 6 6 0 6
M	ETA 802.002 - HM
D	Silver
C	Ø 30.00 mm
B	28.00 mm / 14.00 mm - Jewelry clasp



K4G23121 lady	
EAN	 7 6 1 2 6 3 5 0 8 6 5 9 0
M	ETA 802.002 - HM
D	Black
C	Ø 30.00 mm
B	28.00 mm / 14.00 mm - Jewelry clasp





K4G23526 lady	
EAN	 7 6 1 2 6 3 5 0 8 6 6 1 3
M	ETA 802.002 - HM
D	Silver
C	Ø 30.00 mm
B	28.00 mm / 14.00 mm - Jewelry clasp





K4G23626 lady	
EAN	 7 6 1 2 6 3 5 0 8 6 6 2 0
M	ETA 802.002 - HM
D	Silver
C	Ø 30.00 mm
B	28.00 mm / 14.00 mm - Jewelry clasp

Calvin Klein impetuous





K4F2N116 lady adjustable	
EAN	 7 612635 083537
M	ETA 901.001 - HM
D	Silver
C	 35.00 x 30.00 mm





K4F2N111 lady adjustable	
EAN	 7 612635 083520
M	ETA 901.001 - HM
D	Black
C	 35.00 x 30.00 mm



K4F2N516 lady adjustable	
EAN	 7 612635 084848
M	ETA 901.001 - HM
D	Silver
C	 35.00 x 30.00 mm



K4F2N616 lady adjustable	
EAN	 7 612635 084855
M	ETA 901.001 - HM
D	Silver
C	 35.00 x 30.00 mm

Calvin Klein impulsive



K3T23126 lady	
EAN	 7 6 1 2 6 3 5 0 8 2 8 7 5
M	ETA 901.001 - HM
D	Silver
C	Ø 27.00 mm
B	30.00 mm / 22.00 mm - Sliding buckle



K3T23121 lady	
EAN	 7 6 1 2 6 3 5 0 8 2 8 6 8
M	ETA 901.001 - HM
D	Black
C	Ø 27.00 mm
B	30.00 mm / 22.00 mm - Sliding buckle



K3T23128 lady	
EAN	 7 6 1 2 6 3 5 0 8 2 8 8 2
M	ETA 901.001 - HM
D	Mirror
C	Ø 27.00 mm
B	30.00 mm / 30.00 mm - Sliding buckle



K3T23526 lady	
EAN	 7 6 1 2 6 3 5 0 8 2 8 9 9
M	ETA 901.001 - HM
D	Silver
C	Ø 27.00 mm
B	30.00 mm / 22.00 mm - Sliding buckle



K3T23626 lady	
EAN	 7 6 1 2 6 3 5 0 8 2 9 0 5
M	ETA 901.001 - HM
D	Silver
C	Ø 27.00 mm
B	30.00 mm / 22.00 mm - Sliding buckle

Calvin Klein equal



K3E231L6 lady	
EAN	 7 612635 076201
M	ETA F03.111 - HM
D	Silver
C	Ø 40.50 mm
B	14.00 mm / 14.00 mm - Pin buckle



K3E236L6 lady	
EAN	 7 612635 076218
M	ETA F03.111 - HM
D	Silver
C	Ø 40.50 mm
B	14.00 mm / 14.00 mm - Pin buckle



K3E231C1 lady	
EAN	 7 612635 076188
M	ETA F03.111 - HM
D	Black
C	Ø 40.50 mm
B	14.00 mm / 14.00 mm - Pin buckle

Calvin Klein formality



K4M211C6 gent	
EAN	7 612635 087184
M	ETA F07.111 - HMS date at 3h.
D	Silver
C	Ø 43.50 mm
B	22.00 mm / 20.00 mm - Butterfly buckle



K4M211C3 gent	
EAN	7 612635 087177
M	ETA F07.111 - HMS date at 3h.
D	Cool grey
C	Ø 43.50 mm
B	22.00 mm / 20.00 mm - Butterfly buckle



K4M215C6 gent	
EAN	7 612635 087214
M	ETA F07.111 - HMS date at 3h.
D	Silver
C	Ø 43.50 mm
B	22.00 mm / 20.00 mm - Butterfly buckle



K4M216C3 gent	
EAN	7 612635 087221
M	ETA F07.111 - HMS date at 3h.
D	Cool grey
C	Ø 43.50 mm
B	22.00 mm / 20.00 mm - Butterfly buckle



K4M21146 gent	
EAN	7 612635 087207
M	ETA F07.111 - HMS date at 3h.
D	Silver
C	Ø 43.50 mm
B	19.00 mm / 22.00 mm - Butterfly buckle



K4M21143 gent	
EAN	7 612635 087191
M	ETA F07.111 - HMS date at 3h.
D	Cool grey
C	Ø 43.50 mm
B	19.00 mm / 22.00 mm - Butterfly buckle

Calvin Klein subtle



K0V23120 lady	
EAN	7 6 1 2 6 3 5 0 6 2 2 9 7
M	ETA F03.111 - HM
D	Silver
C	Ø 46.00 mm
B	22.00 mm / 22.00 mm - Pin buckle



K0V23107 lady	
EAN	7 6 1 2 6 3 5 0 6 2 3 0 3
M	ETA F03.111 - HM
D	Cool grey
C	Ø 46.00 mm
B	22.00 mm / 22.00 mm - Pin buckle



K0V23303 lady	
EAN	7 6 1 2 6 3 5 0 6 3 7 0 6
M	ETA F03.111 - HM
D	Brown
C	Ø 46.00 mm
B	22.00 mm / 22.00 mm - Pin buckle



K9423101 lady	
EAN	7 6 1 2 6 3 5 0 5 9 5 3 2
M	ETA F03.111 - HM
D	White
C	Ø 42.00 mm
B	22.00 mm / 22.00 mm - Pin buckle



K9423107 lady	
EAN	7 6 1 2 6 3 5 0 5 9 5 4 9
M	ETA F03.111 - HM
D	Black
C	Ø 42.00 mm
B	22.00 mm / 22.00 mm - Pin buckle

Calvin Klein lively



K4U231K2 lady	
EAN	 7 6 1 2 6 3 5 0 9 0 1 6 0
M	ETA 802.002 - HM
D	White
C	Ø 34.00 mm
B	10.50 mm / 6.00 mm - Pin buckle



K4U231XE lady	
EAN	 7 6 1 2 6 3 5 0 9 0 1 7 7
M	ETA 802.002 - HM
D	MOP Beige
C	Ø 34.00 mm
B	10.50 mm / 6.00 mm - Pin buckle



K4U231VN lady	
EAN	 7 6 1 2 6 3 5 0 9 0 1 5 3
M	ETA 802.002 - HM
D	Blue
C	Ø 34.00 mm
B	10.50 mm / 6.00 mm - Pin buckle



K4U231B1 lady	
EAN	 7 6 1 2 6 3 5 0 9 0 1 4 6
M	ETA 802.002 - HM
D	Black
C	Ø 34.00 mm
B	10.50 mm / 6.00 mm - Pin buckle



K4U23126 lady	
EAN	 7 6 1 2 6 3 5 0 8 8 6 4 8
M	ETA 802.002 - HM
D	Silver
C	Ø 34.00 mm
B	10.50 mm / 5.50 mm - Butterfly buckle



K4U23121 lady	
EAN	 7 6 1 2 6 3 5 0 8 8 6 3 1
M	ETA 802.002 - HM
D	Black
C	Ø 34.00 mm
B	10.50 mm / 5.50 mm - Butterfly buckle

Calvin Klein amaze



K5D2S126 lady small	
EAN	 7 6 1 2 6 3 5 0 9 0 7 4 0
M	ETA 802.002 - HM
D	Silver
C	□ 21.95 x 26.85 mm
B	13.40 mm - Jewelry clasp



K5D2S121 lady small	
EAN	 7 6 1 2 6 3 5 0 9 0 7 2 6
M	ETA 802.002 - HM
D	Black
C	□ 21.95 x 26.85 mm
B	13.40 mm - Jewelry clasp



K5D2M126 lady medium	
EAN	 7 6 1 2 6 3 5 0 9 0 7 5 7
M	ETA 802.002 - HM
D	Silver
C	□ 21.95 x 26.85 mm
B	13.40 mm - Jewelry clasp



K5D2M121 lady medium	
EAN	 7 6 1 2 6 3 5 0 9 0 7 3 3
M	ETA 802.002 - HM
D	Black
C	□ 21.95 x 26.85 mm
B	13.40 mm - Jewelry clasp

Calvin Klein time



K4N21146 gent	
EAN	7 6 1 2 6 3 5 0 8 7 7 7 1
M	ETA F07.111 - HMS date at 3h.
D	Silver
C	Ø 40.00 mm
B	20.00 mm / 20.00 mm - Butterfly buckle



K4N21141 gent	
EAN	7 6 1 2 6 3 5 0 8 7 7 6 4
M	ETA F07.111 - HMS date at 3h.
D	Black
C	Ø 40.00 mm
B	20.00 mm / 20.00 mm - Butterfly buckle



K4N2114N gent	
EAN	7 6 1 2 6 3 5 0 8 7 9 4 8
M	ETA F07.111 - HMS date at 3h.
D	Blue
C	Ø 40.00 mm
B	20.00 mm / 20.00 mm - Butterfly buckle



K4N21646 gent	
EAN	7 6 1 2 6 3 5 0 8 7 7 9 5
M	ETA F07.111 - HMS date at 3h.
D	Silver
C	Ø 40.00 mm
B	20.00 mm / 20.00 mm - Butterfly buckle

Calvin Klein time



K4N23146 lady	
EAN	 7 6 1 2 6 3 5 0 8 6 6 4 4
M	ETA F06.111 - HMS date at 3h.
D	Silver
C	Ø 36.00 mm
B	18.00 mm / 18.00 mm - Butterfly buckle



K4N23141 lady	
EAN	 7 6 1 2 6 3 5 0 8 6 6 3 7
M	ETA F06.111 - HMS date at 3h.
D	Black
C	Ø 36.00 mm
B	18.00 mm / 18.00 mm - Butterfly buckle



K4N2314N lady	
EAN	 7 6 1 2 6 3 5 0 8 7 9 6 2
M	ETA F06.111 - HMS date at 3h.
D	Blue
C	Ø 36.00 mm
B	18.00 mm / 18.00 mm - Butterfly buckle



K4N23646 lady	
EAN	 7 6 1 2 6 3 5 0 8 6 6 6 8
M	ETA F06.111 - HMS date at 3h.
D	Silver
C	Ø 36.00 mm
B	18.00 mm / 18.00 mm - Butterfly buckle

Calvin Klein district



K0Q21120 gent	
EAN	
M	ETA F05.111 - HMS date at 6h.
D	Silver
C	35.00 x 48.80 mm
B	28.00 mm / 20.00 mm - Butterfly buckle



K0Q21107 gent	
EAN	
M	ETA F05.111 - HMS date at 6h.
D	Cool grey
C	35.00 x 48.80 mm
B	28.00 mm / 20.00 mm - Butterfly buckle



K5A311C6 gent	
EAN	
M	ETA 802.102 - HMS
D	Silver
C	Ø 41.00 mm
B	22.00 mm / 20.00 mm - Pin buckle



K5A311C1 gent	
EAN	
M	ETA 802.102 - HMS
D	Black
C	Ø 41.00 mm
B	22.00 mm / 20.00 mm - Pin buckle



K5A316C1 gent	
EAN	
M	ETA 802.102 - HMS
D	Black
C	Ø 41.00 mm
B	22.00 mm / 20.00 mm - Pin buckle

Calvin Klein bold



K5A31146 gent	
EAN	 7 612635 089881
M	ETA 802.102 - HMS
D	Silver
C	Ø 41.00 mm
B	22.00 mm / 19.00 mm - Butterfly buckle



K5A31141 gent	
EAN	 7 612635 089874
M	ETA 802.102 - HMS
D	Black
C	Ø 41.00 mm
B	22.00 mm / 19.00 mm - Butterfly buckle



K5A3114X gent	
EAN	 7 612635 089928
M	ETA 802.102 - HMS
D	Light blue
C	Ø 41.00 mm
B	22.00 mm / 19.00 mm - Butterfly buckle



K5A3114N gent	
EAN	 7 612635 089911
M	ETA 802.102 - HMS
D	Blue
C	Ø 41.00 mm
B	22.00 mm / 19.00 mm - Butterfly buckle



K5A271C6 gent chronograph	
EAN	 7 612635 089942
M	ETA G10.211 - HMS CHR date at 4h.
D	Silver
C	Ø 41.00 mm
B	22.00 mm / 20.00 mm - Pin buckle



K5A27141 gent chronograph	
EAN	 7 612635 089959
M	ETA G10.211 - HMS CHR date at 4h.
D	Black
C	Ø 41.00 mm
B	22.00 mm / 19.00 mm - Butterfly buckle

Calvin Klein stately



K3G23126 lady	
EAN	 7 612635 078113
M	ETA 901.001 - HM
D	Silver
C	Ø 33.50 mm
B	16.00 mm / 16.00 mm - Jewelry clasp



K3G23121 lady	
EAN	 7 612635 078106
M	ETA 901.001 - HM
D	Black
C	Ø 33.50 mm
B	16.00 mm / 16.00 mm - Jewelry clasp



K3G23526 lady	
EAN	 7 612635 078120
M	ETA 901.001 - HM
D	Silver
C	Ø 33.50 mm
B	16.00 mm / 16.00 mm - Jewelry clasp



K3G23626 lady	
EAN	 7 612635 078137
M	ETA 901.001 - HM
D	Silver
C	Ø 33.50 mm
B	16.00 mm / 16.00 mm - Jewelry clasp

Calvin Klein simplicity



K4323126 lady	
EAN	 7 6 1 2 6 3 5 0 3 0 6 3 0
M	ETA 901.001 - HM
D	Silver
C	Ø 28.00 mm
B	10.00 mm / 10.00 mm - Butterfly buckle



K4323130 lady	
EAN	 7 6 1 2 6 3 5 0 3 0 6 4 7
M	ETA 901.001 - HM
D	Black
C	Ø 28.00 mm
B	10.00 mm / 10.00 mm - Butterfly buckle



K4323120 lady	
EAN	 7 6 1 2 6 3 5 0 3 4 0 9 6
M	ETA 901.001 - HM
D	Metallic
C	Ø 28.00 mm
B	10.00 mm / 10.00 mm - Butterfly buckle
single cut 0.0420 cts	



K4323185 lady	
EAN	 7 6 1 2 6 3 5 0 3 8 3 3 9
M	ETA 901.001 - HM
D	Silver
C	Ø 28.00 mm
B	10.00 mm / 10.00 mm - Butterfly buckle



K2G231C6 lady	
EAN	7 6 1 2 6 3 5 0 8 2 7 5 2
M	ETA F05.111 - HM
D	Silver
C	Ø 30.90 mm
B	16.00 mm / 16.00 mm - Pin buckle



K2G23107 lady	
EAN	7 6 1 2 6 3 5 0 7 3 4 4 6
M	ETA F05.111 - HM
D	Cool grey
C	Ø 30.90 mm
B	16.00 mm / 16.00 mm - Pin buckle



K2G211C6 gent	
EAN	7 6 1 2 6 3 5 0 8 2 7 2 1
M	ETA F05.111 - HM
D	Silver
C	Ø 43.00 mm
B	22.00 mm / 20.00 mm - Pin buckle



K2G21107 gent	
EAN	7 6 1 2 6 3 5 0 6 5 8 6 1
M	ETA F05.111 - HM
D	Cool grey
C	Ø 43.00 mm
B	22.00 mm / 20.00 mm - Pin buckle

Calvin Klein city



K2G23120 lady	
EAN	7 6 1 2 6 3 5 0 7 3 4 5 3
M	ETA F05.111 - HM
D	Silver
C	Ø 30.90 mm
B	16.00 mm / 16.00 mm - Pin buckle



K2G23620 lady	
EAN	7 6 1 2 6 3 5 0 7 3 4 9 1
M	ETA F05.111 - HM
D	Silver
C	Ø 30.90 mm
B	16.00 mm / 16.00 mm - Pin buckle



K2G21138 gent	
EAN	7 6 1 2 6 3 5 0 6 7 8 9 6
M	ETA F05.111 - HM
D	Silver
C	Ø 43.00 mm
B	22.00 mm / 20.00 mm - Pin buckle



K2G21520 gent	
EAN	7 6 1 2 6 3 5 0 6 8 0 1 5
M	ETA F05.111 - HM
D	Silver
C	Ø 43.00 mm
B	22.00 mm / 20.00 mm - Pin buckle



K2G21629 gent	
EAN	7 6 1 2 6 3 5 0 7 0 0 4 9
M	ETA F05.111 - HM
D	Silver
C	Ø 43.00 mm
B	22.00 mm / 20.00 mm - Pin buckle

Calvin Klein city



K2G23126 lady	
EAN	 7 6 1 2 6 3 5 0 7 3 4 7 7
M	ETA F05.111 - HM
D	Silver
C	Ø 30.90 mm
B	16.00 mm / 16.00 mm - Butterfly buckle



K2G23161 lady	
EAN	 7 6 1 2 6 3 5 0 7 3 4 6 0
M	ETA F05.111 - HM
D	Cool grey
C	Ø 30.90 mm
B	16.00 mm / 16.00 mm - Butterfly buckle



K2G2314N lady	
EAN	 7 6 1 2 6 3 5 0 8 4 8 6 2
M	ETA F05.111 - HM
D	Blue
C	Ø 30.90 mm
B	16.00 mm / 16.00 mm - Butterfly buckle



K2G21126 gent	
EAN	 7 6 1 2 6 3 5 0 6 7 9 0 2
M	ETA F05.111 - HM
D	Silver
C	Ø 43.00 mm
B	22.00 mm / 20.00 mm - Butterfly buckle



K2G21161 gent	
EAN	 7 6 1 2 6 3 5 0 6 7 8 8 9
M	ETA F05.111 - HM
D	Cool grey
C	Ø 43.00 mm
B	22.00 mm / 19.00 mm - Butterfly buckle



K2G2114N gent	
EAN	 7 6 1 2 6 3 5 0 8 3 4 8 3
M	ETA F05.111 - HM
D	Blue
C	Ø 43.00 mm
B	22.00 mm / 19.00 mm - Butterfly buckle

Calvin Klein city



K2G23546 lady	
EAN	7 612635 082769
M	ETA F05.111 - HM
D	Silver
C	Ø 30.90 mm
B	16.00 mm / 16.00 mm - Butterfly buckle



K2G23646 lady	
EAN	7 612635 082776
M	ETA F05.111 - HM
D	Silver
C	Ø 30.90 mm
B	16.00 mm / 16.00 mm - Butterfly buckle



K2G21546 gent	
EAN	7 612635 082738
M	ETA F05.111 - HM
D	Silver
C	Ø 43.00 mm
B	22.00 mm / 19.00 mm - Butterfly buckle



K2G21646 gent	
EAN	7 612635 082745
M	ETA F05.111 - HM
D	Silver
C	Ø 43.00 mm
B	22.00 mm / 19.00 mm - Butterfly buckle

Calvin Klein city



K2G271C6 gent chronograph	
EAN	7 612635 081595
M	ETA G10.211 - HMS CHR date at 4h.
D	Silver
C	Ø 43.00 mm
B	22.00 mm / 20.00 mm - Pin buckle



K2G276G3 gent chronograph	
EAN	7 612635 081960
M	ETA G10.211 - HMS CHR date at 4h.
D	Cool grey
C	Ø 43.00 mm
B	22.00 mm / 20.00 mm - Pin buckle



K2G271C3 gent chronograph	
EAN	7 612635 081588
M	ETA G10.211 - HMS CHR date at 4h.
D	Cool grey
C	Ø 43.00 mm
B	20.00 mm / 22.00 mm - Pin buckle



K2G275C6 gent chronograph	
EAN	7 612635 081618
M	ETA G10.211 - HMS CHR date at 4h.
D	Silver
C	Ø 43.00 mm
B	22.00 mm / 20.00 mm - Pin buckle

Calvin Klein city



K2G27146 gent chronograph	
EAN	 7 6 1 2 6 3 5 0 8 1 5 6 4
M	ETA G10.211 - HMS CHR date at 4h.
D	Silver
C	Ø 43.00 mm
B	22.00 mm / 19.00 mm - Butterfly buckle



K2G27143 gent chronograph	
EAN	 7 6 1 2 6 3 5 0 8 1 5 5 7
M	ETA G10.211 - HMS CHR date at 4h.
D	Cool grey
C	Ø 43.00 mm
B	22.00 mm / 19.00 mm - Butterfly buckle



K2G2714N gent chronograph	
EAN	 7 6 1 2 6 3 5 0 8 4 0 6 0
M	ETA G10.211 - HMS CHR date at 4h.
D	Blue
C	Ø 43.00 mm
B	22.00 mm / 19.00 mm - Butterfly buckle



K4B371B6 gent chronograph	
EAN	 7 6 1 2 6 3 5 0 8 1 5 1 9
M	ETA G10.211 - HMS CHR date at 4h.
D	Silver
C	Ø 45.42 mm
B	30.00 mm / 22.00 mm - Pin buckle



K4B371B3 gent chronograph	
EAN	 7 6 1 2 6 3 5 0 8 1 5 0 2
M	ETA G10.211 - HMS CHR date at 4h.
D	Cool grey
C	Ø 45.42 mm
B	30.00 mm / 22.00 mm - Pin buckle

Calvin Klein classic



K4D231G6 lady	
EAN	 7 6 1 2 6 3 5 0 8 1 8 3 0
M	ETA F03.111 - HM
D	Silver
C	Ø 24.00 mm
B	12.00 mm / 10.00 mm - Pin buckle



K4D221G6 midsize	
EAN	 7 6 1 2 6 3 5 0 8 1 7 6 2
M	ETA F03.111 - HM
D	Silver
C	Ø 32.00 mm
B	16.00 mm / 14.00 mm - Pin buckle



K4D211G6 gent	
EAN	 7 6 1 2 6 3 5 0 8 1 6 9 4
M	ETA F03.111 - HM
D	Silver
C	Ø 38.00 mm
B	20.00 mm / 17.00 mm - Pin buckle



K4D231CX lady	
EAN	 7 6 1 2 6 3 5 0 8 1 8 2 3
M	ETA F03.111 - HM
D	Black
C	Ø 24.00 mm
B	12.00 mm / 10.00 mm - Pin buckle



K4D221CX midsize	
EAN	 7 6 1 2 6 3 5 0 8 1 7 5 5
M	ETA F03.111 - HM
D	Black
C	Ø 32.00 mm
B	16.00 mm / 14.00 mm - Pin buckle



K4D211CX gent	
EAN	 7 6 1 2 6 3 5 0 8 1 6 8 7
M	ETA F03.111 - HM
D	Black
C	Ø 38.00 mm
B	20.00 mm / 17.00 mm - Pin buckle

Calvin Klein classic



K4D231C1 lady	
EAN	 7 612635 081816
M	ETA F03.111 - HM
D	Black
C	Ø 24.00 mm
B	12.00 mm / 10.00 mm - Pin buckle

K4D221C1 midsize	
EAN	 7 612635 081748
M	ETA F03.111 - HM
D	Black
C	Ø 32.00 mm
B	16.00 mm / 14.00 mm - Pin buckle

K4D211C1 gent	
EAN	 7 612635 081670
M	ETA F03.111 - HM
D	Black
C	Ø 38.00 mm
B	20.00 mm / 17.00 mm - Pin buckle

Calvin Klein classic



K4D2314Z lady	
EAN	7 612635 081809
M	ETA F03.111 - HM
D	Silver
C	Ø 24.00 mm
B	12.00 mm / 10.00 mm - Butterfly buckle



K4D2214Z midsize	
EAN	7 612635 081731
M	ETA F03.111 - HM
D	Silver
C	Ø 32.00 mm
B	16.00 mm / 15.00 mm - Butterfly buckle



K4D2114Z gent	
EAN	7 612635 081663
M	ETA F03.111 - HM
D	Silver
C	Ø 38.00 mm
B	20.00 mm / 19.00 mm - Butterfly buckle



K4D2114Y gent	
EAN	7 612635 081656
M	ETA F03.111 - HM
D	Black
C	Ø 38.00 mm
B	20.00 mm / 19.00 mm - Butterfly buckle

Calvin Klein accent



K2Y231K6 lady	
EAN	 7 6 1 2 6 3 5 0 7 5 1 4 3
M	ETA 980.163 - HMss
D	Silver
C	Ø 32.00 mm
B	16.00 mm / 16.00 mm - Pin buckle



K2Y231C3 lady	
EAN	 7 6 1 2 6 3 5 0 7 5 1 2 9
M	ETA 980.163 - HMss
D	Cool grey
C	Ø 32.00 mm
B	16.00 mm / 16.00 mm - Pin buckle



K2Y236K6 lady	
EAN	 7 6 1 2 6 3 5 0 7 5 1 5 0
M	ETA 980.163 - HMss
D	Silver
C	Ø 32.00 mm
B	16.00 mm / 16.00 mm - Pin buckle



K2Y211K6 gent	
EAN	 7 6 1 2 6 3 5 0 7 5 0 9 9
M	ETA 980.163 - HMss
D	Silver
C	Ø 40.50 mm
B	20.00 mm / 20.00 mm - Pin buckle



K2Y211C3 gent	
EAN	 7 6 1 2 6 3 5 0 7 5 0 5 1
M	ETA 980.163 - HMss
D	Cool grey
C	Ø 40.50 mm
B	20.00 mm / 20.00 mm - Pin buckle



K2Y216K6 gent	
EAN	 7 6 1 2 6 3 5 0 7 5 1 1 2
M	ETA 980.163 - HMss
D	Silver
C	Ø 40.50 mm
B	20.00 mm / 20.00 mm - Pin buckle

Calvin Klein minimal



K3M231CS lady	
EAN	7 6 1 2 6 3 5 0 8 0 8 4 0
M	ETA 901.001 - HM
D	Black
C	Ø 24.00 mm
B	12.00 mm / 11.00 mm - Pin buckle
single cut 0.0120 cts	



K3M221CS midsize	
EAN	7 6 1 2 6 3 5 0 8 0 8 3 3
M	ETA 901.001 - HM
D	Black
C	Ø 35.00 mm
B	18.00 mm / 15.00 mm - Pin buckle
single cut 0.0120 cts	



K3M211CS gent	
EAN	7 6 1 2 6 3 5 0 8 0 8 2 6
M	ETA 901.001 - HM
D	Black
C	Ø 40.00 mm
B	20.00 mm / 17.00 mm - Pin buckle
single cut 0.0120 cts	



K3M23126 lady	
EAN	7 6 1 2 6 3 5 0 7 6 9 7 3
M	ETA 901.001 - HM
D	Silver
C	Ø 24.00 mm
B	11.95 mm / 12.00 mm - Sliding buckle



K3M22126 midsize	
EAN	7 6 1 2 6 3 5 0 7 6 9 3 5
M	ETA 901.001 - HM
D	Silver
C	Ø 35.00 mm
B	17.95 mm / 16.00 mm - Sliding buckle



K3M21126 gent	
EAN	7 6 1 2 6 3 5 0 7 6 8 9 8
M	ETA 901.001 - HM
D	Silver
C	Ø 40.00 mm
B	19.95 mm / 18.00 mm - Sliding buckle

Calvin Klein minimal



K3M23124 lady	
EAN	 7 6 1 2 6 3 5 0 7 6 9 6 6
M	ETA 901.001 - HM
D	Dark grey
C	Ø 24.00 mm
B	11.95 mm / 12.00 mm - Sliding buckle



K3M22124 midsize	
EAN	 7 6 1 2 6 3 5 0 7 6 9 2 8
M	ETA 901.001 - HM
D	Dark grey
C	Ø 35.00 mm
B	17.95 mm / 16.00 mm - Sliding buckle



K3M21124 gent	
EAN	 7 6 1 2 6 3 5 0 7 6 8 8 1
M	ETA 901.001 - HM
D	Dark grey
C	Ø 40.00 mm
B	19.95 mm / 18.00 mm - Sliding buckle

Calvin Klein postminimal



K7622185 lady	
EAN	
M	ETA 956.032 - HM
D	Silver
C	Ø 29.00 mm
B	16.00 mm / 16.00 mm - Pin buckle



K7622220 midsize	
EAN	
M	ETA 955.102 - HMS
D	Silver
C	Ø 34.00 mm
B	18.00 mm / 18.00 mm - Pin buckle



K7621192 gent	
EAN	
M	ETA 955.102 - HMS
D	Silver
C	Ø 42.00 mm
B	22.00 mm / 20.00 mm - Pin buckle



K7622207 midsize	
EAN	
M	ETA 955.102 - HMS
D	Cool grey
C	Ø 34.00 mm
B	18.00 mm / 18.00 mm - Pin buckle



K7621107 gent	
EAN	
M	ETA 955.102 - HMS
D	Cool grey
C	Ø 42.00 mm
B	22.00 mm / 20.00 mm - Pin buckle



K7621401 gent	
EAN	
M	ETA 955.102 - HMS
D	Black
C	Ø 42.00 mm
B	22.00 mm / 20.00 mm - Pin buckle

Calvin Klein postminimal



K7627401 gent chronograph	
EAN	 7 6 1 2 6 3 5 0 6 3 6 8 3
M	ETA G10.211 - HMS CHR date at 4h.
D	Black
C	Ø 42.00 mm
B	22.00 mm / 20.00 mm - Pin buckle



K7627161 gent chronograph	
EAN	 7 6 1 2 6 3 5 0 5 5 9 9 2
M	ETA G10.211 - HMS CHR date at 4h.
D	Cool grey
C	Ø 42.00 mm
B	22.00 mm / 22.00 mm - Butterfly buckle



K1S21120 gent	
EAN	 7 6 1 2 6 3 5 0 6 4 8 0 2
M	ETA F05.111 - HMS
D	Silver
C	Ø 40.00 mm
B	21.00 mm / 20.00 mm - Pin buckle



K1S21102 gent	
EAN	 7 6 1 2 6 3 5 0 6 4 7 9 6
M	ETA F05.111 - HMS
D	Black
C	Ø 40.00 mm
B	21.00 mm / 20.00 mm - Pin buckle

Calvin Klein
swiss made

Calvin Klein delight



K1A2351G lady small	
EAN	7 612635 084909
M	ETA 901.001 - HM
D	MOP White
C	34.00 x 28.00 mm

K1A2311F lady small	
EAN	7 612635 084886
M	ETA 901.001 - HM
D	MOP black
C	34.00 x 28.00 mm



K1A2371G lady medium	
EAN	7 612635 084916
M	ETA 901.001 - HM
D	MOP White
C	34.00 x 28.00 mm

K1A2361F lady medium	
EAN	7 612635 084893
M	ETA 901.001 - HM
D	MOP black
C	34.00 x 28.00 mm

Calvin Klein suspension



K3323330 lady	
EAN	 7 6 1 2 6 3 5 0 1 8 4 4 7
M	ETA 901.001 - HM
D	Black
C	□ 31.00 x 45.00 mm



K3323409 lady	
EAN	 7 6 1 2 6 3 5 0 1 8 4 5 4
M	ETA 901.001 - HM
D	PVD 1N14
C	□ 31.00 x 45.00 mm



K1P23120 lady	
EAN	 7 6 1 2 6 3 5 0 6 4 8 2 6
M	ETA F03.111 - HM
D	Silver
C	∅ 30.00 mm
B	34.00 mm / 20.00 mm - Jewelry clasp



K1P23102 lady	
EAN	 7 6 1 2 6 3 5 0 6 4 8 1 9
M	ETA F03.111 - HM
D	Black
C	∅ 30.00 mm
B	34.00 mm / 20.00 mm - Jewelry clasp

Calvin Klein incentive



K3P23126 lady	
EAN	7 612635 086163
M	ETA 901.001 - HM
D	Silver
C	□ 24.17 x 30.82 mm
B	12.00 mm / 12.00 mm - Sliding buckle



K3P23121 lady	
EAN	7 612635 086156
M	ETA 901.001 - HM
D	Black
C	□ 24.17 x 30.82 mm
B	12.00 mm / 12.00 mm - Sliding buckle



K3P236G6 lady	
EAN	7 612635 078939
M	ETA 901.001 - HM
D	Silver
C	□ 24.17 x 30.82 mm
B	12.00 mm / 12.00 mm - Pin buckle



K3N23126 lady	
EAN	7 612635 086149
M	ETA 901.001 - HM
D	Silver
C	∅ 28.50 mm
B	12.00 mm / 12.00 mm - Sliding buckle



K3N23121 lady	
EAN	7 612635 086132
M	ETA 901.001 - HM
D	Black
C	∅ 28.50 mm
B	12.00 mm / 12.00 mm - Sliding buckle



K3N236G6 lady	
EAN	7 612635 078892
M	ETA 901.001 - HM
D	Silver
C	∅ 28.50 mm
B	12.00 mm / 12.00 mm - Pin buckle

Calvin Klein mirror



K2824130 lady small	
EAN	 7 6 1 2 6 3 5 0 1 4 7 8 4
M	ETA 901.001 - HM
D	Black
C	Ø 34.00 mm



K2824203 lady small	
EAN	 7 6 1 2 6 3 5 0 5 8 5 1 1
M	ETA 901.001 - HM
D	Brown
C	Ø 34.00 mm



K2823130 lady medium	
EAN	 7 6 1 2 6 3 5 0 1 4 7 5 3
M	ETA 901.001 - HM
D	Black
C	Ø 34.00 mm



K2823203 lady medium	
EAN	 7 6 1 2 6 3 5 0 5 8 5 2 8
M	ETA 901.001 - HM
D	Brown
C	Ø 34.00 mm

Calvin Klein

CALVIN KLEIN NOVELTIES JEWELRY

Calvin Klein opposite (KJ3Z)	68
Calvin Klein wonder (KJ4V)	69
Calvin Klein fluid (KJ3X)	70
Calvin Klein ellipse (KJ3Q)	71
Calvin Klein ceramic (KJ3L)	74
Calvin Klein audacious (KJ4C)	76
Calvin Klein wonder (KJ4V)	78
Calvin Klein magnet (KJ4D)	80
Calvin Klein spellbound (KJ0D)	82
Calvin Klein ellipse (KJ3Q)	88
Calvin Klein constructed (KJ3P)	91
Calvin Klein breathe (KJ3D)	92
Calvin Klein daring (KJ3H)	94
Calvin Klein joyous (KJ2X)	95
Calvin Klein daring (KJ3H)	96
Calvin Klein edge (KJ3C)	100
Calvin Klein hook (KJ06)	104

Calvin Klein

Calvin Klein opposite



PO/BR
st
steel
STEEL PVD
black

long pendant

KJ3ZBP280100		7 6 1 2 6 3 5 0 9 6 9 1 9
S	800.00 mm adjustable at 500.00 mm / 36.00 mm x 44.00 mm	



PO/BR
st
steel
STEEL PVD
black

bracelet

KJ3ZBB280100		7 6 1 2 6 3 5 0 9 6 9 0 2
S	180.00 mm	



PO/BR
st
steel
STEEL PVD
black

ring

KJ3ZBR280106		7 6 1 2 6 3 5 0 9 6 8 7 2
6	Ø 16.55 mm	
KJ3ZBR280107		7 6 1 2 6 3 5 0 9 6 8 8 9
7	Ø 17.35 mm	
KJ3ZBR280108		7 6 1 2 6 3 5 0 9 6 8 9 6
8	Ø 18.15 mm	

Calvin Klein

Calvin Klein opposite



PO/BR
st
steel
steel PVD
black

drop earrings

KJ3ZBE280100		
S	13.00 mm x	7 6 1 2 6 3 5 0 9 6 9 2 6



PO/BR
st
steel
steel PVD
black

stud earrings

KJ3ZBE280200		
S	13.00 mm x	7 6 1 2 6 3 5 0 9 6 9 3 3



PO
st
steel

set of 3 rings

KJ4VMR000105		
5	Ø 15.75 mm	7 6 1 2 6 3 5 0 9 9 1 0 1
KJ4VMR000106		
6	Ø 16.55 mm	7 6 1 2 6 3 5 0 9 9 1 1 8
KJ4VMR000107		
7	Ø 17.35 mm	7 6 1 2 6 3 5 0 9 9 1 2 5
KJ4VMR000108		
8	Ø 18.15 mm	7 6 1 2 6 3 5 0 9 9 1 3 2

Calvin Klein

Calvin Klein fluid



short pendant	
KJ3XMP000100	
S	500.00 mm / Ø 30.00 mm
7 6 1 2 6 3 5 0 9 8 4 9 4	



closed bangle	
KJ3XMD0001XS	
XS	54.00 mm x 43.00 mm
7 6 1 2 6 3 5 0 9 8 5 1 7	
KJ3XMD0001OS	
S	58.00 mm x 46.00 mm
7 6 1 2 6 3 5 0 9 8 5 2 4	
KJ3XMD0001OM	
M	62.00 mm x 49.00 mm
7 6 1 2 6 3 5 0 9 8 5 3 1	



creole earrings	
KJ3XME000100	
S	26.00 mm x 20.00 mm
7 6 1 2 6 3 5 0 9 8 5 0 0	



ring	
KJ3XMR000105	
5	Ø 15.75 mm
7 6 1 2 6 3 5 0 9 8 5 4 8	
KJ3XMR000106	
6	Ø 16.55 mm
7 6 1 2 6 3 5 0 9 8 5 6 2	
KJ3XMR000107	
7	Ø 17.35 mm
7 6 1 2 6 3 5 0 9 8 5 7 9	
KJ3XMR000108	
8	Ø 18.15 mm
7 6 1 2 6 3 5 0 9 8 5 8 6	

Calvin Klein

Calvin Klein ellipse



closed bangle		
KJ3QMD0001XS		
XS	54.00 mm x 43.00 mm	7 6 1 2 6 3 5 0 9 9 8 6 6
KJ3QMD0001OS		
S	58.00 mm x 46.00 mm	7 6 1 2 6 3 5 0 9 9 8 7 3
KJ3QMD0001OM		
M	62.00 mm x 49.00 mm	7 6 1 2 6 3 5 0 9 9 8 8 0



ring		
KJ3QMR000106		
6	Ø 16.55 mm	7 6 1 2 6 3 5 0 9 9 8 3 5
KJ3QMR000107		
7	Ø 17.35 mm	7 6 1 2 6 3 5 0 9 9 8 4 2
KJ3QMR000108		
8	Ø 18.15 mm	7 6 1 2 6 3 5 0 9 9 8 5 9





drop earrings		
KJ3QME000100		
S	7.00 mm x	7 6 1 2 6 3 5 0 9 9 8 9 7



Calvin Klein

Calvin Klein ellipse



closed bangle		
KJ3QJD1001XS		
XS	54.00 mm x 43.00 mm	7 6 1 2 6 3 5 1 0 0 0 2 9
KJ3QJD1001OS		
S	58.00 mm x 46.00 mm	7 6 1 2 6 3 5 1 0 0 0 3 6
KJ3QJD1001OM		
M	62.00 mm x 49.00 mm	7 6 1 2 6 3 5 1 0 0 0 4 3



ring		
KJ3QJR100106		
6	Ø 16.55 mm	7 6 1 2 6 3 5 0 9 9 9 9 6
KJ3QJR100107		
7	Ø 17.35 mm	7 6 1 2 6 3 5 1 0 0 0 0 5
KJ3QJR100108		
8	Ø 18.15 mm	7 6 1 2 6 3 5 1 0 0 0 1 2



drop earrings		
KJ3QJE100100		
S	7.00 mm x	7 6 1 2 6 3 5 1 0 0 0 5 0

Calvin Klein

Calvin Klein ellipse



closed bangle		
KJ3QPD1001XS		
XS	54.00 mm x 43.00 mm	7 6 1 2 6 3 5 0 9 9 9 4 1
KJ3QPD1001OS		
S	58.00 mm x 46.00 mm	7 6 1 2 6 3 5 0 9 9 9 5 8
KJ3QPD1001OM		
M	62.00 mm x 49.00 mm	7 6 1 2 6 3 5 0 9 9 9 6 5



drop earrings		
KJ3QPE100100		
S	7.00 mm x	7 6 1 2 6 3 5 0 9 9 9 7 2



ring		
KJ3QPR100106		
6	Ø 16.55 mm	7 6 1 2 6 3 5 0 9 9 9 1 0
KJ3QPR100107		
7	Ø 17.35 mm	7 6 1 2 6 3 5 0 9 9 9 2 7
KJ3QPR100108		
8	Ø 18.15 mm	7 6 1 2 6 3 5 0 9 9 9 3 4

Calvin Klein

Calvin Klein ceramic



Icons: Calvin Klein logo, PO, st steel

long necklace	
KJ3LWN090100	
S	1,000.00 mm



7 6 1 2 6 3 5 0 9 6 8 4 1



Icons: Calvin Klein logo, PO, st steel

bracelet	
KJ3LWB090100	
S	180.00 mm



7 6 1 2 6 3 5 0 9 6 8 5 8



Icons: Calvin Klein logo, PO, st steel

drop earrings	
KJ3LWE090100	
S	14.70 mm x



7 6 1 2 6 3 5 0 9 6 8 6 5

Calvin Klein

Calvin Klein ceramic



Icons: Calvin Klein logo, PO, st steel

long necklace	
KJ3LBN090100	
S	1,000.00 mm



7 6 1 2 6 3 5 0 9 6 8 1 0



Icons: Calvin Klein logo, PO, st steel

bracelet	
KJ3LBB090100	
S	180.00 mm



7 6 1 2 6 3 5 0 9 6 8 2 7



Icons: Calvin Klein logo, PO, st steel

drop earrings	
KJ3LBE090100	
S	14.70 mm x



7 6 1 2 6 3 5 0 9 6 8 3 4

Calvin Klein

Calvin Klein audacious



short pendant	
KJ4CMP280100	
S	550.00 mm / 10.40 mm x 46.00 mm
 7 6 1 2 6 3 5 0 9 8 6 0 9	



ring	
KJ4CMR280107	
7	Ø 17.35 mm
KJ4CMR280108	
8	Ø 18.15 mm
KJ4CMR280109	
9	Ø 19.00 mm
KJ4CMR280110	
10	Ø 19.84 mm
KJ4CMR280111	
11	Ø 20.37 mm
KJ4CMR280112	
12	Ø 21.26 mm



cufflinks	
KJ4CMC280100	
S	9.50 mm x
 7 6 1 2 6 3 5 0 9 8 7 0 8	

Calvin Klein

Calvin Klein audacious



bracelet	
KJ4CMB090100	
S	210.00 mm
7 6 1 2 6 3 5 0 9 9 5 3 8	



bracelet	
KJ4CMB090200	
S	410.00 mm
7 6 1 2 6 3 5 0 9 9 5 4 5	



bracelet	
KJ4CMB280100	
S	210.00 mm
7 6 1 2 6 3 5 0 9 8 6 1 6	

Calvin Klein

Calvin Klein wonder



short necklace	
KJ4VJN200100	
S	500.00 mm
7 6 1 2 6 3 5 0 9 9 2 5 5	



short pendant	
KJ4VJP200100	
S	850.00 mm / 40.00 mm x 43.00 mm
7 6 1 2 6 3 5 0 9 9 2 6 2	



bracelet	
KJ4VJB200100	
S	180.00 mm
7 6 1 2 6 3 5 0 9 9 2 8 6	



hanging earrings	
KJ4VJE200100	
S	50.00 mm
7 6 1 2 6 3 5 0 9 9 2 7 9	

Calvin Klein

Calvin Klein wonder



short necklace	
KJ4VPN200100	
S	500.00 mm
 7 6 1 2 6 3 5 0 9 9 1 9 4	



long pendant	
KJ4VPP200100	
S	850.00 mm / 40.00 mm x 43.00 mm
 7 6 1 2 6 3 5 0 9 9 2 2 4	



bracelet	
KJ4VPB200100	
S	180.00 mm
 7 6 1 2 6 3 5 0 9 9 2 4 8	



hanging earrings	
KJ4VPE200100	
S	50.00 mm
 7 6 1 2 6 3 5 0 9 9 2 3 1	

Calvin Klein

Calvin Klein magnet



short pendant	
KJ4DBP210100	
S	550.00 mm / 16.00 mm x 42.00 mm
 7 6 1 2 6 3 5 0 9 8 7 1 5	



ring	
KJ4DBR210107	
7	Ø 17.35 mm
KJ4DBR210108	
8	Ø 18.15 mm
KJ4DBR210109	
9	Ø 19.00 mm
KJ4DBR210110	
10	Ø 19.84 mm
KJ4DBR210111	
11	Ø 20.37 mm
KJ4DBR210112	
12	Ø 21.26 mm



cufflinks	
KJ4DBC210100	
S	9.50 mm x
 7 6 1 2 6 3 5 0 9 8 8 1 4	

Calvin Klein

Calvin Klein magnet



bracelet	
KJ4DBB390100	
S	210.00 mm
7 6 1 2 6 3 5 0 9 8 7 4 6	



bracelet	
KJ4DBB210100	
S	210.00 mm
7 6 1 2 6 3 5 0 9 8 7 2 2	

Calvin Klein

Calvin Klein spellbound



ring	
KJODAR090106	
6	Ø 16.55 mm
KJODAR090107	
7	Ø 17.35 mm
KJODAR090108	
8	Ø 18.15 mm
KJODAR090109	
9	Ø 19.00 mm



long necklace	
KJODAN090100	
S	800.00 mm adjustable at 450.00 mm



round bangle	
KJODAD09010S	
S	Ø 65.00 mm

Calvin Klein

Calvin Klein spellbound



white



ring	
KJODVRO90206	
6	Ø 16.55 mm
KJODVRO90207	
7	Ø 17.35 mm
KJODVRO90208	
8	Ø 18.15 mm
KJODVRO90209	
9	Ø 19.00 mm



white



long necklace	
KJODWN090200	
S	800.00 mm adjustable at 450.00 mm



white



round bangle	
KJODW090205	
S	Ø 65.00 mm

Calvin Klein

Calvin Klein spellbound



ring	
KJODBR090206	
6	Ø 16.55 mm
KJODBR090207	
7	Ø 17.35 mm
KJODBR090208	
8	Ø 18.15 mm
KJODBR090209	
9	Ø 19.00 mm



long necklace	
KJODBN090200	
S	800.00 mm adjustable at 450.00 mm



round bangle	
KJODBD09020S	
S	Ø 65.00 mm

Calvin Klein

Calvin Klein spellbound



ring	
KJODBR190106	
6	Ø 16.55 mm
KJODBR190107	
7	Ø 17.35 mm
KJODBR190108	
8	Ø 18.15 mm
KJODBR190109	
9	Ø 19.00 mm



long necklace	
KJODBN190100	
S	800.00 mm adjustable at 450.00 mm



round bangle	
KJODBD19010S	
S	Ø 65.00 mm

Calvin Klein

Calvin Klein spellbound



ring		
KJODJRO90106		
6	Ø 16.55 mm	7 6 1 2 6 3 5 0 9 5 8 3 7
KJODJRO90107		
7	Ø 17.35 mm	7 6 1 2 6 3 5 0 9 5 8 4 4
KJODJRO90108		
8	Ø 18.15 mm	7 6 1 2 6 3 5 0 9 5 8 5 1
KJODJRO90109		
9	Ø 19.00 mm	7 6 1 2 6 3 5 0 9 5 8 6 8



long necklace		
KJODJNO90100		
S	800.00 mm adjustable at 450.00 mm	7 6 1 2 6 3 5 0 9 5 9 8 1



round bangle		
KJODJDO9010S		
S	Ø 65.00 mm	7 6 1 2 6 3 5 0 9 5 8 7 5

Calvin Klein

Calvin Klein spellbound



blue



ring	
KJODLRO90106	
6	Ø 16.55 mm
KJODLRO90107	
7	Ø 17.35 mm
KJODLRO90108	
8	Ø 18.15 mm
KJODLRO90109	
9	Ø 19.00 mm



blue



long necklace	
KJODLN090100	
S	800.00 mm adjustable at 450.00 mm



blue





round bangle	
KJODLD09010S	
S	Ø 65.00 mm

Calvin Klein

Calvin Klein ellipse



ring	
KJ3QWRO20106	
6	Ø 16.55 mm
KJ3QWRO20107	
7	Ø 17.35 mm
KJ3QWRO20108	
8	Ø 18.15 mm



long pendant	
KJ3QWPO20100	
S	800.00 mm / 27.00 mm x 41.00 mm



drop earrings	
KJ3QWE020100	
S	7.00 mm x



closed bangle	
KJ3QWD0201XS	
XS	54.00 mm x 43.00 mm
KJ3QWD02010S	
S	58.00 mm x 46.00 mm
KJ3QWD02010M	
M	62.00 mm x 49.00 mm

Calvin Klein

Calvin Klein ellipse



ring	
KJ3QCR020106	
6	Ø 16.55 mm
KJ3QCR020107	
7	Ø 17.35 mm
KJ3QCR020108	
8	Ø 18.15 mm



long pendant	
KJ3QCP020100	
S	800.00 mm / 27.00 mm x 41.00 mm



drop earrings	
KJ3QCE020100	
S	7.00 mm x





closed bangle	
KJ3QCD0201XS	
XS	54.00 mm x 43.00 mm
KJ3QCD0201OS	
S	58.00 mm x 46.00 mm
KJ3QCD0201OM	
M	62.00 mm x 49.00 mm

Calvin Klein

Calvin Klein ellipse



ring	
KJ3QLR020106	
6	Ø 16.55 mm
KJ3QLR020107	
7	Ø 17.35 mm
KJ3QLR020108	
8	Ø 18.15 mm



long pendant	
KJ3QLP020100	
S	800.00 mm / 27.00 mm x 41.00 mm



drop earrings	
KJ3QLE020100	
S	7.00 mm x

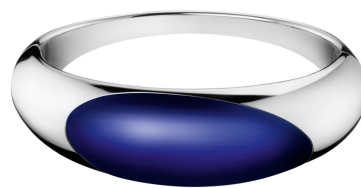

closed bangle	
KJ3QLD0201XS	
XS	54.00 mm x 43.00 mm
KJ3QLD0201OS	
S	58.00 mm x 46.00 mm
KJ3QLD0201OM	
M	62.00 mm x 49.00 mm

Calvin Klein

Calvin Klein constructed



black



ring	
KJ3PMR090107	
7	∅ 17.35 mm
KJ3PMR090108	
8	∅ 18.15 mm
KJ3PMR090109	
9	∅ 19.00 mm
KJ3PMR090110	
10	∅ 19.84 mm
KJ3PMR090111	
11	∅ 20.37 mm
KJ3PMR090112	
12	∅ 21.26 mm



black



short pendant	
KJ3PMP290100	
S	550.00 mm / 24.00 mm x 38.00 mm



black



cufflinks	
KJ3PMC090100	
S	x



black



closed bangle	
KJ3PMD09010M	
M	62.00 mm x 49.00 mm
KJ3PMD09010L	
L	65.00 mm x 51.00 mm
KJ3PMD0901XL	
XL	68.00 mm x 54.00 mm

Calvin Klein

Calvin Klein breathe



choker	
KJ3DMJ080100	
S	140.00 mm x /
 7 6 1 2 6 3 5 0 9 4 5 9 5	



closed bangle	
KJ3DMD0801XS	
XS	54.00 mm x 43.00 mm
 7 6 1 2 6 3 5 0 9 3 9 5 6	
KJ3DMD0801OS	
S	58.00 mm x 46.00 mm
 7 6 1 2 6 3 5 0 9 3 9 6 3	
KJ3DMD0801OM	
M	62.00 mm x 49.00 mm
 7 6 1 2 6 3 5 0 9 3 9 7 0	



creole earrings	
KJ3DME080100	
S	35.00 mm x 33.00 mm
 7 6 1 2 6 3 5 0 9 3 9 8 7	



ring	
KJ3DMR080105	
5	∅ 15.75 mm
 7 6 1 2 6 3 5 0 9 3 9 0 1	
KJ3DMR080106	
6	∅ 16.55 mm
 7 6 1 2 6 3 5 0 9 3 9 1 8	
KJ3DMR080107	
7	∅ 17.35 mm
 7 6 1 2 6 3 5 0 9 3 9 2 5	
KJ3DMR080108	
8	∅ 18.15 mm
 7 6 1 2 6 3 5 0 9 3 9 3 2	
KJ3DMR080109	
9	∅ 19.00 mm
 7 6 1 2 6 3 5 0 9 3 9 4 9	

Calvin Klein

Calvin Klein breathe



choker	
KJ3DPJ200100	
S	140.00 mm x /
7 6 1 2 6 3 5 0 9 4 6 0 1	



closed bangle	
KJ3DPD2001XS	
XS	54.00 mm x 43.00 mm
KJ3DPD20010S	
S	58.00 mm x 46.00 mm
KJ3DPD20010M	
M	62.00 mm x 49.00 mm
7 6 1 2 6 3 5 0 9 4 0 4 5	
7 6 1 2 6 3 5 0 9 4 0 5 2	
7 6 1 2 6 3 5 0 9 4 0 6 9	



creole earrings	
KJ3DPE200100	
S	35.00 mm x 33.00 mm
7 6 1 2 6 3 5 0 9 4 0 7 6	



ring	
KJ3DPR200105	
5	∅ 15.75 mm
KJ3DPR200106	
6	∅ 16.55 mm
KJ3DPR200107	
7	∅ 17.35 mm
KJ3DPR200108	
8	∅ 18.15 mm
KJ3DPR200109	
9	∅ 19.00 mm
7 6 1 2 6 3 5 0 9 3 9 9 4	
7 6 1 2 6 3 5 0 9 4 0 0 7	
7 6 1 2 6 3 5 0 9 4 0 1 4	
7 6 1 2 6 3 5 0 9 4 0 2 1	
7 6 1 2 6 3 5 0 9 4 0 3 8	

Calvin Klein

Calvin Klein daring



long necklace		
KJ3HMN000100		
S	1,000.00 mm	7 6 1 2 6 3 5 0 9 4 0 8 3



bracelet		
KJ3HMB000100		
S	180.00 mm	7 6 1 2 6 3 5 0 9 4 0 9 0



drop earrings		
KJ3HME000200		
S	8.00 mm x 5.00 mm	7 6 1 2 6 3 5 0 9 4 1 1 3



ring		
KJ3HMR000105		
5	Ø 15.75 mm	7 6 1 2 6 3 5 0 9 4 1 2 0
KJ3HMR000106		
6	Ø 16.55 mm	7 6 1 2 6 3 5 0 9 4 1 3 7
KJ3HMR000107		
7	Ø 17.35 mm	7 6 1 2 6 3 5 0 9 4 1 4 4
KJ3HMR000108		
8	Ø 18.15 mm	7 6 1 2 6 3 5 0 9 4 1 5 1
KJ3HMR000109		
9	Ø 19.00 mm	7 6 1 2 6 3 5 0 9 4 1 6 8

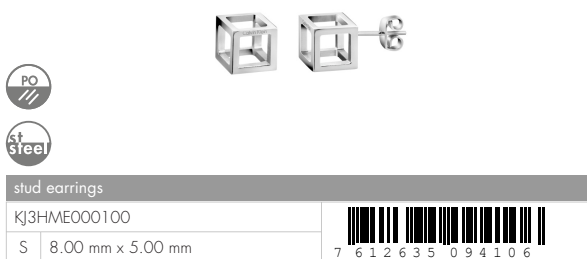

Calvin Klein

Calvin Klein daring



stud earrings	
KJ3HME000100	
S	8.00 mm x 5.00 mm
 7 6 1 2 6 3 5 0 9 4 1 0 6	



ring	
KJ3HMR040106	
6	Ø 16.55 mm
KJ3HMR040107	
7	Ø 17.35 mm
KJ3HMR040108	
8	Ø 18.15 mm
 7 6 1 2 6 3 5 0 9 6 4 5 2	
 7 6 1 2 6 3 5 0 9 6 4 6 9	
 7 6 1 2 6 3 5 0 9 6 4 7 6	

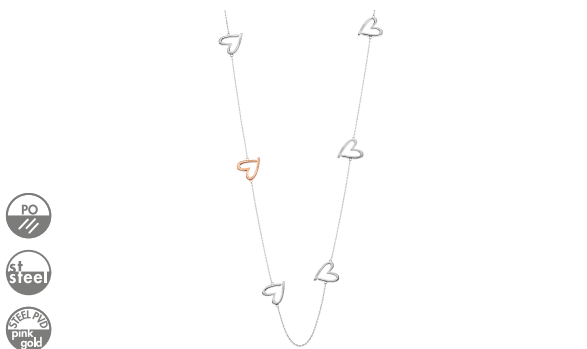

long necklace	
KJ2XPN200100	
S	800.00 mm
 7 6 1 2 6 3 5 0 9 3 2 7 7	



bracelet	
KJ2XPB200100	
S	180.00 mm
 7 6 1 2 6 3 5 0 9 3 2 6 0	

Calvin Klein

Calvin Klein daring



long necklace		
KJ3HJN100100		
S	1,000.00 mm	7 6 1 2 6 3 5 0 9 4 1 7 5



bracelet		
KJ3HJB100100		
S	180.00 mm	7 6 1 2 6 3 5 0 9 4 1 8 2



ring		
KJ3HJR100105		
5	Ø 15.75 mm	7 6 1 2 6 3 5 0 9 4 2 2 9
KJ3HJR100106		
6	Ø 16.55 mm	7 6 1 2 6 3 5 0 9 4 2 3 6
KJ3HJR100107		
7	Ø 17.35 mm	7 6 1 2 6 3 5 0 9 4 2 4 3
KJ3HJR100108		
8	Ø 18.15 mm	7 6 1 2 6 3 5 0 9 4 2 5 0
KJ3HJR100109		
9	Ø 19.00 mm	7 6 1 2 6 3 5 0 9 4 2 6 7



drop earrings		
KJ3HJE100200		
S	8.00 mm x 5.00 mm	7 6 1 2 6 3 5 0 9 4 2 0 5



Calvin Klein

Calvin Klein daring



stud earrings	
KJ3HJE100100	
S	8.00 mm x 5.00 mm
7 6 1 2 6 3 5 0 9 4 1 9 9	



ring	
KJ3HJR140106	
6	Ø 16.55 mm
KJ3HJR140107	
7	Ø 17.35 mm
KJ3HJR140108	
8	Ø 18.15 mm
7 6 1 2 6 3 5 0 9 6 4 8 3	
7 6 1 2 6 3 5 0 9 6 4 9 0	
7 6 1 2 6 3 5 0 9 6 5 0 6	

Calvin Klein

Calvin Klein daring



long necklace		
KJ3HPN100100		
S	1,000.00 mm	7 6 1 2 6 3 5 0 9 4 2 7 4



bracelet		
KJ3HPB100100		
S	180.00 mm	7 6 1 2 6 3 5 0 9 4 2 8 1



ring		
KJ3HPR100105		
5	Ø 15.75 mm	7 6 1 2 6 3 5 0 9 4 3 1 1
KJ3HPR100106		
6	Ø 16.55 mm	7 6 1 2 6 3 5 0 9 4 3 2 8
KJ3HPR100107		
7	Ø 17.35 mm	7 6 1 2 6 3 5 0 9 4 3 3 5
KJ3HPR100108		
8	Ø 18.15 mm	7 6 1 2 6 3 5 0 9 4 3 4 2
KJ3HPR100109		
9	Ø 19.00 mm	7 6 1 2 6 3 5 0 9 4 3 5 9



drop earrings		
KJ3HPE100200		
S	8.00 mm x 5.00 mm	7 6 1 2 6 3 5 0 9 4 3 0 4

Calvin Klein

Calvin Klein daring





PO
KSEL PINK gold

stud earrings	
KJ3HPE100100	
S	8.00 mm x 5.00 mm
7 6 1 2 6 3 5 0 9 4 2 9 8	



G
white
PO
KSEL PINK gold

ring	
KJ3HPR140106	
6	Ø 16.55 mm
KJ3HPR140107	
7	Ø 17.35 mm
KJ3HPR140108	
8	Ø 18.15 mm
7 6 1 2 6 3 5 0 9 6 5 1 3	
7 6 1 2 6 3 5 0 9 6 5 2 0	
7 6 1 2 6 3 5 0 9 6 5 3 7	

Calvin Klein

Calvin Klein edge



short pendant		
KJ3CMP000200		
S	500.00 mm / 30.00 mm x	7 6 1 2 6 3 5 0 9 5 2 2 6



bracelet		
KJ3CMB000100		
S	200.00 mm	7 6 1 2 6 3 5 0 9 5 1 5 8



stud earrings		
KJ3CME000100		
S	8.00 mm x	7 6 1 2 6 3 5 0 9 5 2 3 3



ring		
KJ3CMR000105		
5	Ø 15.75 mm	7 6 1 2 6 3 5 0 9 5 1 6 5
KJ3CMR000106		
6	Ø 16.55 mm	7 6 1 2 6 3 5 0 9 5 1 7 2
KJ3CMR000107		
7	Ø 17.35 mm	7 6 1 2 6 3 5 0 9 5 1 8 9
KJ3CMR000108		
8	Ø 18.15 mm	7 6 1 2 6 3 5 0 9 5 1 9 6
KJ3CMR000109		
9	Ø 19.00 mm	7 6 1 2 6 3 5 0 9 5 2 0 2

Calvin Klein

Calvin Klein edge



short pendant		
KJ3CBP100200		
S	500.00 mm / 30.00 mm x	7 6 1 2 6 3 5 0 9 5 3 1 8



bracelet		
KJ3CBB100100		
S	200.00 mm	7 6 1 2 6 3 5 0 9 5 2 4 0



stud earrings		
KJ3CBE100100		
S	8.00 mm x	7 6 1 2 6 3 5 0 9 5 3 2 5



ring		
KJ3CBR100105		
5	Ø 15.75 mm	7 6 1 2 6 3 5 0 9 5 2 5 7
KJ3CBR100106		
6	Ø 16.55 mm	7 6 1 2 6 3 5 0 9 5 2 6 4
KJ3CBR100107		
7	Ø 17.35 mm	7 6 1 2 6 3 5 0 9 5 2 7 1
KJ3CBR100108		
8	Ø 18.15 mm	7 6 1 2 6 3 5 0 9 5 2 8 8
KJ3CBR100109		
9	Ø 19.00 mm	7 6 1 2 6 3 5 0 9 5 2 9 5

Calvin Klein

Calvin Klein edge



short pendant		
KJ3CPPF100200		
S	500.00 mm / 30.00 mm x	7 6 1 2 6 3 5 0 9 5 4 0 0



bracelet		
KJ3CPB100100		
S	200.00 mm	7 6 1 2 6 3 5 0 9 5 3 3 2



stud earrings		
KJ3CPE100100		
S	8.00 mm x	7 6 1 2 6 3 5 0 9 5 4 1 7



ring		
KJ3CPR100105		
5	Ø 15.75 mm	7 6 1 2 6 3 5 0 9 5 3 4 9
KJ3CPR100106		
6	Ø 16.55 mm	7 6 1 2 6 3 5 0 9 5 3 5 6
KJ3CPR100107		
7	Ø 17.35 mm	7 6 1 2 6 3 5 0 9 5 3 6 3
KJ3CPR100108		
8	Ø 18.15 mm	7 6 1 2 6 3 5 0 9 5 3 7 0
KJ3CPR100109		
9	Ø 19.00 mm	7 6 1 2 6 3 5 0 9 5 3 8 7

Calvin Klein

Calvin Klein edge



PO
steel

short pendant
KJ3CMP000100

S	500.00 mm / Ø 11.00 mm	7 6 1 2 6 3 5 0 9 5 2 1 9
---	------------------------	---------------------------



PO
steel / PVD
Black

short pendant
KJ3CBP100100

S	500.00 mm / Ø 11.00 mm	7 6 1 2 6 3 5 0 9 5 3 0 1
---	------------------------	---------------------------



PO
steel / PVD
pink gold

short pendant
KJ3CPP100100

S	500.00 mm / Ø 11.00 mm	7 6 1 2 6 3 5 0 9 5 3 9 4
---	------------------------	---------------------------

Calvin Klein

Calvin Klein hook



closed bangle		
KJ06WDO401XS		
XS	54.00 mm x 43.00 mm	7 6 1 2 6 3 5 0 9 3 3 6 9
KJ06WDO401OS		
S	58.00 mm x 46.00 mm	7 6 1 2 6 3 5 0 9 3 3 7 6
KJ06WDO401OM		
M	62.00 mm x 49.00 mm	7 6 1 2 6 3 5 0 9 3 3 8 3
KJ06WDO401OL		
L	65.00 mm x 51.00 mm	7 6 1 2 6 3 5 0 9 3 3 9 0



ring		
KJ06WR040106		
6	∅ 16.55 mm	7 6 1 2 6 3 5 0 9 3 4 0 6
KJ06WR040107		
7	∅ 17.35 mm	7 6 1 2 6 3 5 0 9 3 4 1 3
KJ06WR040108		
8	∅ 18.15 mm	7 6 1 2 6 3 5 0 9 3 4 2 0
KJ06WR040109		
9	∅ 19.00 mm	7 6 1 2 6 3 5 0 9 3 4 3 7
KJ06WR040110		
10	∅ 19.84 mm	7 6 1 2 6 3 5 0 9 3 4 4 4
KJ06WR040111		
11	∅ 20.37 mm	7 6 1 2 6 3 5 0 9 3 4 5 1



ring		
KJ06WR040205		
5	∅ 15.75 mm	7 6 1 2 6 3 5 0 9 3 5 6 7
KJ06WR040206		
6	∅ 16.55 mm	7 6 1 2 6 3 5 0 9 3 5 7 4
KJ06WR040207		
7	∅ 17.35 mm	7 6 1 2 6 3 5 0 9 3 5 8 1
KJ06WR040208		
8	∅ 18.15 mm	7 6 1 2 6 3 5 0 9 3 5 9 8
KJ06WR040209		
9	∅ 19.00 mm	7 6 1 2 6 3 5 0 9 3 6 0 4

Calvin Klein

Calvin Klein hook



closed bangle	
KJ06BD0401XS	
XS 54.00 mm x 43.00 mm	7 6 1 2 6 3 5 0 9 3 4 6 8
KJ06BD0401OS	
S 58.00 mm x 46.00 mm	7 6 1 2 6 3 5 0 9 3 4 7 5
KJ06BD0401OM	
M 62.00 mm x 49.00 mm	7 6 1 2 6 3 5 0 9 3 4 8 2
KJ06BD0401OL	
L 65.00 mm x 51.00 mm	7 6 1 2 6 3 5 0 9 3 4 9 9



ring	
KJ06BR040106	
6 Ø 16.55 mm	7 6 1 2 6 3 5 0 9 3 5 0 5
KJ06BR040107	
7 Ø 17.35 mm	7 6 1 2 6 3 5 0 9 3 5 1 2
KJ06BR040108	
8 Ø 18.15 mm	7 6 1 2 6 3 5 0 9 3 5 2 9
KJ06BR040109	
9 Ø 19.00 mm	7 6 1 2 6 3 5 0 9 3 5 3 6
KJ06BR040110	
10 Ø 19.84 mm	7 6 1 2 6 3 5 0 9 3 5 4 3
KJ06BR040111	
11 Ø 20.37 mm	7 6 1 2 6 3 5 0 9 3 5 5 0



ring	
KJ06BR040205	
5 Ø 15.75 mm	7 6 1 2 6 3 5 0 9 3 6 1 1
KJ06BR040206	
6 Ø 16.55 mm	7 6 1 2 6 3 5 0 9 3 6 2 8
KJ06BR040207	
7 Ø 17.35 mm	7 6 1 2 6 3 5 0 9 3 6 3 5
KJ06BR040208	
8 Ø 18.15 mm	7 6 1 2 6 3 5 0 9 3 6 4 2
KJ06BR040209	
9 Ø 19.00 mm	7 6 1 2 6 3 5 0 9 3 6 5 9

Calvin Klein

CALVIN KLEIN CORE COLLECTION JEWELRY

Calvin Klein invigorate (KJ2F)	108
Calvin Klein sumptuous (KJ2G)	110
Calvin Klein desirable (KJ1P)	113
Calvin Klein body (KJ2W)	114
Calvin Klein joyous (KJ2X)	115
Calvin Klein crisp (KJ1R)	118
Calvin Klein bewilder (KJ2B)	120
Calvin Klein straight (KJ0Q)	121
Calvin Klein impulsive (KJ1W)	122
Calvin Klein hook (KJ06)	122
Calvin Klein continue (KJ0E)	123
Calvin Klein born (KJ94)	124
Calvin Klein coil (KJ63)	126
Calvin Klein return (KJ0Z)	128
Calvin Klein exclusive (KJ0K)	130
Calvin Klein spellbound (KJ0D)	132
Calvin Klein intense (KJ2H)	136
Calvin Klein embrace (KJ2K)	138
Calvin Klein wish (KJ12)	139
Calvin Klein Jeans Waves (KJ17)	139
Calvin Klein Jeans Astound (KJ81)	140
Calvin Klein embrace (KJ2K)	142

Calvin Klein

Calvin Klein invigorate



short pendant		
KJ2FMP080100		
S	490.00 mm / 18.00 mm x 35.00 mm	7 6 1 2 6 3 5 0 8 8 1 1 2



bracelet		
KJ2FMB080100		
S	220.00 mm	7 6 1 2 6 3 5 0 8 8 1 2 9



cufflinks		
KJ2FMC080100		
S	12.00 mm x 15.50 mm	7 6 1 2 6 3 5 0 8 8 1 3 6

Calvin Klein

Calvin Klein invigorate



PO/BR
st
steel
steel PVD
black

short pendant

KJ2FBP280100		7 6 1 2 6 3 5 0 8 8 2 1 1
S	490.00 mm / 18.00 mm x 35.00 mm	



PO/BR
st
steel
steel PVD
black

bracelet

KJ2FBB280100		7 6 1 2 6 3 5 0 8 8 2 0 4
S	220.00 mm	



PO/BR
st
steel
steel PVD
black

cufflinks

KJ2FBC280100		7 6 1 2 6 3 5 0 8 8 2 2 8
S	12.00 mm x 15.50 mm	



Calvin Klein

Calvin Klein sumptuous



long pendant	
KJ2GMP000100	
S	800.00 mm adjustable at 500.00 mm / Ø 40.70 mm
	
7 6 1 2 6 3 5 0 8 9 0 3 4	





round bangle with closure	
KJ2GMD0001XS	
XS	Ø 54.00 mm
KJ2GMD00010S	
S	Ø 58.00 mm
KJ2GMD00010M	
M	Ø 62.00 mm
	
7 6 1 2 6 3 5 0 8 9 0 6 5	
	
7 6 1 2 6 3 5 0 8 9 0 7 2	
	
7 6 1 2 6 3 5 0 8 9 0 8 9	



creole earrings	
KJ2GME000100	
S	8.00 mm x 19.00 mm
	
7 6 1 2 6 3 5 0 8 9 0 9 6	



ring	
KJ2GMR000105	
5	Ø 15.75 mm
KJ2GMR000106	
6	Ø 16.55 mm
KJ2GMR000107	
7	Ø 17.35 mm
KJ2GMR000108	
8	Ø 18.15 mm
KJ2GMR000109	
9	Ø 19.00 mm
	
7 6 1 2 6 3 5 0 8 8 8 8 4	
	
7 6 1 2 6 3 5 0 8 8 8 9 1	
	
7 6 1 2 6 3 5 0 8 8 9 0 7	
	
7 6 1 2 6 3 5 0 8 8 9 1 4	
	
7 6 1 2 6 3 5 0 8 8 9 2 1	



Calvin Klein

Calvin Klein sumptuous



long pendant	
KJ2GJP100100	
S	800.00 mm adjustable at 500.00 mm / Ø 40.70 mm
 7 6 1 2 6 3 5 0 8 9 0 4 1	



round bangle with closure	
KJ2GJD1001XS	
XS	Ø 54.00 mm
KJ2GJD10010S	
S	Ø 58.00 mm
KJ2GJD10010M	
M	Ø 62.00 mm
 7 6 1 2 6 3 5 0 8 9 1 0 2	
 7 6 1 2 6 3 5 0 8 9 1 1 9	
 7 6 1 2 6 3 5 0 8 9 1 2 6	



creole earrings	
KJ2GJE100100	
S	8.00 mm x 19.00 mm
 7 6 1 2 6 3 5 0 8 9 1 3 3	



ring	
KJ2GJR100105	
5	Ø 15.75 mm
KJ2GJR100106	
6	Ø 16.55 mm
KJ2GJR100107	
7	Ø 17.35 mm
KJ2GJR100108	
8	Ø 18.15 mm
KJ2GJR100109	
9	Ø 19.00 mm
 7 6 1 2 6 3 5 0 8 8 9 3 8	
 7 6 1 2 6 3 5 0 8 8 9 4 5	
 7 6 1 2 6 3 5 0 8 8 9 5 2	
 7 6 1 2 6 3 5 0 8 8 9 6 9	
 7 6 1 2 6 3 5 0 8 8 9 7 6	



Calvin Klein

Calvin Klein sumptuous



long pendant	
KJ2GPP100100	
S	800.00 mm adjustable at 500.00 mm / Ø 40.70 mm
	



round bangle with closure	
KJ2GPD1001XS	
XS	Ø 54.00 mm
	
KJ2GPD10010S	
S	Ø 58.00 mm
	
KJ2GPD10010M	
M	Ø 62.00 mm
	



creole earrings	
KJ2GPE100100	
S	8.00 mm x 19.00 mm
	



ring	
KJ2GPR100105	
5	Ø 15.75 mm
	
KJ2GPR100106	
6	Ø 16.55 mm
	
KJ2GPR100107	
7	Ø 17.35 mm
	
KJ2GPR100108	
8	Ø 18.15 mm
	
KJ2GPR100109	
9	Ø 19.00 mm
	



Calvin Klein

Calvin Klein desirable



short necklace	
KJ1PMN000100	
S 500.00 mm	7 6 1 2 6 3 5 0 8 3 9 3 3



bracelet	
KJ1PMB0001XS	
XS 184.00 mm	7 6 1 2 6 3 5 0 8 3 9 0 2
KJ1PMB0001OS	
S 199.00 mm	7 6 1 2 6 3 5 0 8 3 9 1 9
KJ1PMB0001OM	
M 215.00 mm	7 6 1 2 6 3 5 0 8 3 9 2 6



creole earrings	
KJ1PME000100	
S 18.50 mm x 40.00 mm	7 6 1 2 6 3 5 0 8 3 9 9 5

Calvin Klein

Calvin Klein body



bracelet	
KJ2WMB000100	
S	187.50 mm
 7 6 1 2 6 3 5 0 8 9 9 6 6	



ring	
KJ2WMR000105	
5	Ø 15.75 mm
KJ2WMR000106	
6	Ø 16.20 mm
KJ2WMR000107	
7	Ø 17.35 mm
KJ2WMR000108	
8	Ø 18.50 mm
KJ2WMR000109	
9	Ø 19.00 mm
 7 6 1 2 6 3 5 0 8 9 9 7 3	



bracelet	
KJ2WPB100100	
S	187.50 mm
 7 6 1 2 6 3 5 0 9 0 0 8 5	



ring	
KJ2WPR100105	
5	Ø 15.75 mm
KJ2WPR100106	
6	Ø 16.20 mm
KJ2WPR100107	
7	Ø 17.35 mm
KJ2WPR100108	
8	Ø 18.50 mm
KJ2WPR100109	
9	Ø 19.00 mm
 7 6 1 2 6 3 5 0 9 0 0 9 2	

Calvin Klein

Calvin Klein joyous



PO
st steel

long necklace

KJ2XMN000200	
S 800.00 mm	7 6 1 2 6 3 5 0 8 9 7 9 9



PO
st steel

short necklace

KJ2XMN000100	
S 500.00 mm	7 6 1 2 6 3 5 0 8 9 7 7 5



PO
st steel

bracelet

KJ2XMB0001XS	
XS	7 6 1 2 6 3 5 0 8 9 8 0 5
KJ2XMB00010S	
S	7 6 1 2 6 3 5 0 8 9 8 1 2
KJ2XMB000100	
S 180.00 mm	7 6 1 2 6 3 5 0 9 0 2 7 6
KJ2XMB00010M	
M	7 6 1 2 6 3 5 0 8 9 8 2 9



PO
st steel

creole earrings

KJ2XME000100	
S Ø 20.50 mm	7 6 1 2 6 3 5 0 8 9 8 3 6

Calvin Klein

Calvin Klein joyous



CRYSTA
white

PO
///

st
steel

long necklace

KJ2XWN040200		
S	800.00 mm	

7 6 1 2 6 3 5 0 9 1 3 6 5



CRYSTA
white

PO
///

st
steel

short necklace

KJ2XWN040100		
S	500.00 mm	

7 6 1 2 6 3 5 0 9 1 3 5 8



CRYSTA
white

PO
///

st
steel

bracelet

KJ2XVB040100		
S	180.00 mm	

7 6 1 2 6 3 5 0 9 1 3 8 9

Calvin Klein

Calvin Klein joyous



CRYSTAL
white

PO
///

ROSE GOLD
pink
gold

long necklace

KJ2XWN140200		
S	800.00 mm	

7 6 1 2 6 3 5 0 9 1 4 0 2



CRYSTAL
white

PO
///

ROSE GOLD
pink
gold

short necklace

KJ2XWN140100		
S	500.00 mm	

7 6 1 2 6 3 5 0 9 1 3 9 6



CRYSTAL
white

PO
///

ROSE GOLD
pink
gold

bracelet

KJ2XWB140100		
S	180.00 mm	

7 6 1 2 6 3 5 0 9 1 4 3 3

Calvin Klein

Calvin Klein crisp



short necklace	
KJ1RMN000100	
S 500.00 mm	7 6 1 2 6 3 5 0 8 5 3 6 4



closed bangle	
KJ1RMD0001XS	
XS 54.00 mm x 43.00 mm	7 6 1 2 6 3 5 0 8 5 6 4 7
KJ1RMD0001OS	
S 58.00 mm x 46.00 mm	7 6 1 2 6 3 5 0 8 5 6 5 4
KJ1RMD0001OM	
M 62.00 mm x 49.00 mm	7 6 1 2 6 3 5 0 8 5 6 6 1



creole earrings	
KJ1RME000100	
S 16.60 mm x 29.50 mm	7 6 1 2 6 3 5 0 8 5 4 0 1



ring	
KJ1RMR000105	
5 Ø 15.75 mm	7 6 1 2 6 3 5 0 8 5 4 4 9
KJ1RMR000106	
6 Ø 16.55 mm	7 6 1 2 6 3 5 0 8 5 4 5 6
KJ1RMR000107	
7 Ø 17.35 mm	7 6 1 2 6 3 5 0 8 5 4 6 3
KJ1RMR000108	
8 Ø 18.15 mm	7 6 1 2 6 3 5 0 8 5 4 7 0
KJ1RMR000109	
9 Ø 19.00 mm	7 6 1 2 6 3 5 0 8 5 4 8 7

Calvin Klein

Calvin Klein crisp



- 
- 
- 
- 

short necklace	
KJ1RDN300100	
S	500.00 mm



7 6 1 2 6 3 5 0 8 5 3 7 1



- 
- 
- 
- 

closed bangle	
KJ1RDD3001XS	
XS	54.00 mm x 43.00 mm
KJ1RDD3001OS	
S	58.00 mm x 46.00 mm
KJ1RDD3001OM	
M	62.00 mm x 49.00 mm



7 6 1 2 6 3 5 0 8 5 6 8 5



7 6 1 2 6 3 5 0 8 5 6 9 2



7 6 1 2 6 3 5 0 8 5 7 0 8



- 
- 
- 
- 

creole earrings	
KJ1RDE300100	
S	16.60 mm x 29.50 mm



7 6 1 2 6 3 5 0 8 5 4 1 8



- 
- 
- 
- 

ring	
KJ1RDR300105	
5	∅ 15.75 mm
KJ1RDR300106	
6	∅ 16.55 mm
KJ1RDR300107	
7	∅ 17.35 mm
KJ1RDR300108	
8	∅ 18.15 mm
KJ1RDR300109	
9	∅ 19.00 mm



7 6 1 2 6 3 5 0 8 5 4 9 4



7 6 1 2 6 3 5 0 8 5 5 0 0



7 6 1 2 6 3 5 0 8 5 5 1 7



7 6 1 2 6 3 5 0 8 5 5 2 4





7 6 1 2 6 3 5 0 8 5 5 3 1



Calvin Klein

Calvin Klein bewilder



bracelet	
KJ2BBB09010M	
M 210.00 mm	7 6 1 2 6 3 5 0 8 4 7 8 7
KJ2BBB09010L	
L 230.00 mm	7 6 1 2 6 3 5 0 8 4 7 9 4
KJ2BBB0901XL	
XL 255.00 mm	7 6 1 2 6 3 5 0 8 4 8 0 0



bracelet	
KJ2BCB09010M	
M 210.00 mm	7 6 1 2 6 3 5 0 8 4 8 1 7
KJ2BCB09010L	
L 230.00 mm	7 6 1 2 6 3 5 0 8 4 8 2 4
KJ2BCB0901XL	
XL 255.00 mm	7 6 1 2 6 3 5 0 8 4 8 3 1

Calvin Klein

Calvin Klein straight



short pendant	
KJQMP080100	
S	490.00 mm / 23.00 mm x 35.00 mm
 7 6 1 2 6 3 5 0 8 3 2 5 4	



closed bangle	
KJQMD08010M	
M	62.00 mm x 49.00 mm
 7 6 1 2 6 3 5 0 8 3 2 6 1	
KJQMD08010L	
L	65.00 mm x 51.00 mm
 7 6 1 2 6 3 5 0 8 3 2 7 8	
KJQMD0801XL	
XL	68.00 mm x 54.00 mm
 7 6 1 2 6 3 5 0 8 3 2 8 5	



cufflinks	
KJQMC080100	
S	12.50 mm x 19.00 mm
 7 6 1 2 6 3 5 0 8 3 3 5 3	



Calvin Klein

Calvin Klein impulsive



long necklace	
KJ1WMN000100	
S 1,500.00 mm	7 6 1 2 6 3 5 0 8 5 3 1 9



bracelet	
KJ1WMB0001XS	
XS 166.50 mm	7 6 1 2 6 3 5 0 8 6 8 2 8
KJ1WMB00010S	
S 176.50 mm	7 6 1 2 6 3 5 0 8 6 8 4 2
KJ1WMB00010M	
M 186.50 mm	7 6 1 2 6 3 5 0 8 6 8 5 9



short necklace	
KJ06BN010100	
S 500.00 mm	7 6 1 2 6 3 5 0 2 6 6 8 8



closed bangle	
KJ06CB0101XS	
XS 54.00 mm x 43.00 mm	7 6 1 2 6 3 5 0 3 6 3 9 7
KJ06CB01010S	
S 58.00 mm x 46.00 mm	7 6 1 2 6 3 5 0 3 2 2 4 5
KJ06CB01010M	
M 62.00 mm x 49.00 mm	7 6 1 2 6 3 5 0 3 2 2 5 2
KJ06CB01010L	
L 65.00 mm x 51.00 mm	7 6 1 2 6 3 5 0 3 2 2 6 9
KJ06CB0101XL	
XL 68.00 mm x 54.00 mm	7 6 1 2 6 3 5 0 3 2 2 7 6

Calvin Klein

Calvin Klein continue



PO
st
steel

short pendant

KJOEMP000100	
S 450.00 mm / Ø 17.35 mm	7 6 1 2 6 3 5 0 7 5 7 6 1



PO
st
steel

stud earrings

KJOEME000100	
S Ø 10.00 mm	7 6 1 2 6 3 5 0 7 4 7 4 0



PO
K18E1P10
yellow
gold

short pendant

KJOEJP100100	
S 450.00 mm / Ø 17.35 mm	7 6 1 2 6 3 5 0 7 5 7 7 8



PO
K18E1P10
yellow
gold

stud earrings

KJOEJE100100	
S Ø 10.00 mm	7 6 1 2 6 3 5 0 7 5 7 5 4

Calvin Klein

Calvin Klein born



choker		7 6 1 2 6 3 5 0 7 3 6 2 0
KJ94MJ000100		
S	125.00 mm x 142.50 mm / 30.00 mm	



open bangle		7 6 1 2 6 3 5 0 7 3 5 8 3
KJ94MF0001XS		
XS	54.00 mm x 43.00 mm / 27.00 mm	
KJ94MF00010S		7 6 1 2 6 3 5 0 7 3 5 9 0
S	58.00 mm x 46.00 mm / 27.00 mm	
KJ94MF00010M		7 6 1 2 6 3 5 0 7 3 6 0 6
M	62.00 mm x 49.00 mm / 30.00 mm	



drop earrings		7 6 1 2 6 3 5 0 7 3 6 1 3
KJ94ME000100		
S	4.50 mm x 57.60 mm	

Calvin Klein

Calvin Klein born



choker		
KJ94JJ100100		
S	125.00 mm x 142.50 mm / 30.00 mm	7 6 1 2 6 3 5 0 7 3 7 2 9



drop earrings		
KJ94JE100100		
S	4.50 mm x 57.60 mm	7 6 1 2 6 3 5 0 7 3 7 1 2



choker		
KJ94PJ100100		
S	125.00 mm x 142.50 mm / 30.00 mm	7 6 1 2 6 3 5 0 7 3 8 2 8



drop earrings		
KJ94PE100100		
S	4.50 mm x 57.60 mm	7 6 1 2 6 3 5 0 7 3 8 1 1

Calvin Klein

Calvin Klein coil



long pendant	
KJ63AP010100	
S	700.00 mm / 39.70 mm x 36.50 mm



round bangle	
KJ63AB0101XS	
XS	∅ 60.00 mm
KJ63AB01010S	
S	∅ 65.00 mm
KJ63AB01010M	
M	∅ 70.00 mm



stud earrings	
KJ63AE010100	
S	26.70 mm x 26.70 mm



ring	
KJ63ARO10105	
5	∅ 15.75 mm
KJ63ARO10106	
6	∅ 16.55 mm
KJ63ARO10107	
7	∅ 17.35 mm
KJ63ARO10108	
8	∅ 18.15 mm
KJ63ARO10109	
9	∅ 19.00 mm
KJ63ARO10110	
10	∅ 19.84 mm
KJ63ARO10111	
11	∅ 20.37 mm
KJ63ARO10112	
12	∅ 21.65 mm



Calvin Klein

Calvin Klein coil



long pendant	
KJ63BP010100	
S	800.00 mm adjustable at 450.00 mm / 39.70 mm x 36.50 mm
	







round bangle	
KJ63BB0101XS	
XS	Ø 60.00 mm
KJ63BB01010S	
S	Ø 65.00 mm
KJ63BB01010M	
M	Ø 70.00 mm
	
	
	



stud earrings	
KJ63BE010100	
S	26.70 mm x 26.70 mm
	



ring	
KJ63BR010105	
5	Ø 15.75 mm
KJ63BR010106	
6	Ø 16.55 mm
KJ63BR010107	
7	Ø 17.35 mm
KJ63BR010108	
8	Ø 18.15 mm
KJ63BR010109	
9	Ø 19.00 mm
KJ63BR010110	
10	Ø 19.84 mm
KJ63BR010111	
11	Ø 20.37 mm
KJ63BR010112	
12	Ø 21.65 mm
	
	
	
	
	
	
	
	

Calvin Klein

Calvin Klein return



PO
st steel

short pendant

KJOZMP000100		7 6 1 2 6 3 5 0 8 1 8 9 2
S	500.00 mm / Ø 27.00 mm	



PO
st steel

open bangle

KJOZMF0001XS		7 6 1 2 6 3 5 0 8 0 1 0 9
XS	54.00 mm x 43.00 mm / 27.00 mm	
KJOZMF0001OS		7 6 1 2 6 3 5 0 8 0 1 1 6
S	58.00 mm x 46.00 mm / 27.00 mm	
KJOZMF0001OM		7 6 1 2 6 3 5 0 8 0 1 2 3
M	62.00 mm x 49.00 mm / 30.00 mm	



PO
st steel

creole earrings

KJOZME000100		7 6 1 2 6 3 5 0 8 1 9 2 2
S	Ø 22.00 mm	



PO
st steel

ring

KJOZMR000105		7 6 1 2 6 3 5 0 8 0 1 9 2
5	Ø 15.75 mm	
KJOZMR000106		7 6 1 2 6 3 5 0 8 0 2 0 8
6	Ø 16.55 mm	
KJOZMR000107		7 6 1 2 6 3 5 0 8 0 2 1 5
7	Ø 17.35 mm	
KJOZMR000108		7 6 1 2 6 3 5 0 8 0 2 2 2
8	Ø 18.15 mm	
KJOZMR000109		7 6 1 2 6 3 5 0 8 0 2 3 9
9	Ø 19.00 mm	

Calvin Klein

Calvin Klein return



short pendant	
KJZPP000100	
S	500.00 mm / Ø 27.00 mm
7 6 1 2 6 3 5 0 8 1 9 1 5	

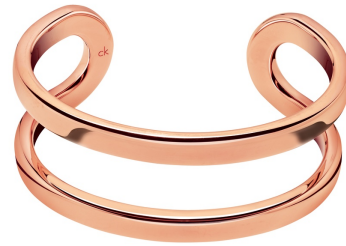

open bangle	
KJZPF0001XS	
XS	54.00 mm x 43.00 mm / 27.00 mm
KJZPF00010S	
S	58.00 mm x 46.00 mm / 27.00 mm
KJZPF00010M	
M	62.00 mm x 49.00 mm / 30.00 mm



creole earrings	
KJZPE000100	
S	Ø 22.00 mm
7 6 1 2 6 3 5 0 8 1 9 4 6	



ring	
KJZPRO00105	
5	Ø 15.75 mm
KJZPRO00106	
6	Ø 16.55 mm
KJZPRO00107	
7	Ø 17.35 mm
KJZPRO00108	
8	Ø 18.15 mm
KJZPRO00109	
9	Ø 19.00 mm

Calvin Klein

Calvin Klein exclusive



short pendant	
KJOKDF300100	
S	500.00 mm / Ø 45.00 mm
 7 6 1 2 6 3 5 0 8 3 2 4 7	



set of 3 round bangles	
KJOKDD3001XS	
XS	Ø 60.00 mm
 7 6 1 2 6 3 5 0 7 7 9 0 1	
KJOKDD30010S	
S	Ø 65.00 mm
 7 6 1 2 6 3 5 0 7 7 9 1 8	
KJOKDD30010M	
M	Ø 70.00 mm
 7 6 1 2 6 3 5 0 7 7 9 2 5	



set of 3 rings	
KJOKDR300105	
5	Ø 15.75 mm
 7 6 1 2 6 3 5 0 7 7 8 5 7	
KJOKDR300106	
6	Ø 16.55 mm
 7 6 1 2 6 3 5 0 7 7 8 6 4	
KJOKDR300107	
7	Ø 17.35 mm
 7 6 1 2 6 3 5 0 7 7 8 7 1	
KJOKDR300108	
8	Ø 18.15 mm
 7 6 1 2 6 3 5 0 7 7 8 8 8	
KJOKDR300109	
9	Ø 19.00 mm
 7 6 1 2 6 3 5 0 7 7 8 9 5	

Calvin Klein

Calvin Klein exclusive



PO
st steel

creole earrings
KJOKME000100

S	Ø 33.40 mm
---	------------

7 6 1 2 6 3 5 0 7 8 1 8 2



PO
KJOKME yellow gold

creole earrings
KJOKJE100100

S	Ø 33.40 mm
---	------------

7 6 1 2 6 3 5 0 7 8 1 9 9



PO
KJOKPE pink gold

creole earrings
KJOKPE100100

S	Ø 33.40 mm
---	------------

7 6 1 2 6 3 5 0 7 8 2 0 5



Calvin Klein

Calvin Klein spellbound







long pendant		
KJODWPO90100		
S	800.00 mm adjustable at 450.00 mm / Ø 40.00 mm	7 6 1 2 6 3 5 0 8 3 6 2 9



round bangle		
KJODWDO901XS		
XS	Ø 60.00 mm	7 6 1 2 6 3 5 0 8 3 5 9 9
KJODWDO9010S		
S	Ø 65.00 mm	7 6 1 2 6 3 5 0 8 3 6 0 5
KJODWDO9010M		
M	Ø 70.00 mm	7 6 1 2 6 3 5 0 8 3 6 1 2



ring		
KJODWRO90105		
5	Ø 15.75 mm	7 6 1 2 6 3 5 0 8 3 5 4 4
KJODWRO90106		
6	Ø 16.55 mm	7 6 1 2 6 3 5 0 8 3 5 5 1
KJODWRO90107		
7	Ø 17.35 mm	7 6 1 2 6 3 5 0 8 3 5 6 8
KJODWRO90108		
8	Ø 18.15 mm	7 6 1 2 6 3 5 0 8 3 5 7 5
KJODWRO90109		
9	Ø 19.00 mm	7 6 1 2 6 3 5 0 8 3 5 8 2

Calvin Klein

Calvin Klein spellbound



long pendant		
KJDBP090100		
S	800.00 mm adjustable at 450.00 mm / Ø 40.00 mm	7 6 1 2 6 3 5 0 7 5 2 8 0



round bangle		
KJDBD0901XS		
XS	Ø 60.00 mm	7 6 1 2 6 3 5 0 7 4 5 6 6
KJDBD09010S		
S	Ø 65.00 mm	7 6 1 2 6 3 5 0 7 4 5 7 3
KJDBD09010M		
M	Ø 70.00 mm	7 6 1 2 6 3 5 0 7 4 5 8 0



ring		
KJDBR090105		
5	Ø 15.75 mm	7 6 1 2 6 3 5 0 7 4 4 8 1
KJDBR090106		
6	Ø 16.55 mm	7 6 1 2 6 3 5 0 7 4 4 9 8
KJDBR090107		
7	Ø 17.35 mm	7 6 1 2 6 3 5 0 7 4 5 0 4
KJDBR090108		
8	Ø 18.15 mm	7 6 1 2 6 3 5 0 7 4 5 1 1
KJDBR090109		
9	Ø 19.00 mm	7 6 1 2 6 3 5 0 7 4 5 2 8
KJDBR090110		
10	Ø 19.84 mm	7 6 1 2 6 3 5 0 7 4 5 3 5
KJDBR090111		
11	Ø 20.37 mm	7 6 1 2 6 3 5 0 7 4 5 4 2
KJDBR090112		
12	Ø 21.26 mm	7 6 1 2 6 3 5 0 7 4 5 5 9



Calvin Klein

Calvin Klein spellbound







long pendant	
KJODJP190100	
S	800.00 mm adjustable at 450.00 mm / Ø 40.00 mm
 7 6 1 2 6 3 5 0 7 5 2 7 3	



round bangle	
KJODJD1901XS	
XS	Ø 60.00 mm
 7 6 1 2 6 3 5 0 7 5 2 4 2	
KJODJD19010S	
S	Ø 65.00 mm
 7 6 1 2 6 3 5 0 7 5 2 5 9	
KJODJD19010M	
M	Ø 70.00 mm
 7 6 1 2 6 3 5 0 7 5 2 6 6	



ring	
KJODJR190105	
5	Ø 15.75 mm
 7 6 1 2 6 3 5 0 7 5 1 8 1	
KJODJR190106	
6	Ø 16.55 mm
 7 6 1 2 6 3 5 0 7 5 2 0 4	
KJODJR190107	
7	Ø 17.35 mm
 7 6 1 2 6 3 5 0 7 5 2 1 1	
KJODJR190108	
8	Ø 18.15 mm
 7 6 1 2 6 3 5 0 7 5 2 2 8	
KJODJR190109	
9	Ø 19.00 mm
 7 6 1 2 6 3 5 0 7 5 2 3 5	

Calvin Klein

Calvin Klein spellbound



 brown
 PO
 Steel/Pink Gold



long pendant	
KJODPP190300	
S	800.00 mm adjustable at 450.00 mm / Ø 40.00 mm
 7 6 1 2 6 3 5 0 8 3 8 9 6	







 black
 PO
 Steel/Pink Gold

round bangle	
KJODBD19010S	
S	Ø 65.00 mm
 7 6 1 2 6 3 5 0 9 5 8 2 0	



 black
 PO
 Steel/Pink Gold

ring	
KJODBR190106	 7 6 1 2 6 3 5 0 9 5 7 8 3
6	Ø 16.55 mm
KJODBR190107	 7 6 1 2 6 3 5 0 9 5 7 9 0
7	Ø 17.35 mm
KJODBR190108	 7 6 1 2 6 3 5 0 9 5 8 0 6
8	Ø 18.15 mm
KJODBR190109	 7 6 1 2 6 3 5 0 9 5 8 1 3
9	Ø 19.00 mm



Calvin Klein

Calvin Klein intense



long pendant	
KJ2HMP080100	
S	800.00 mm adjustable at 500.00 mm / 40.00 mm x 43.00 mm
	
7 6 1 2 6 3 5 0 8 9 2 2 5	



closed bangle	
KJ2HMD0801XS	
XS	54.00 mm x 43.00 mm
	
7 6 1 2 6 3 5 0 8 9 1 9 5	
KJ2HMD0801OS	
S	58.00 mm x 46.00 mm
	
7 6 1 2 6 3 5 0 8 9 2 0 1	
KJ2HMD0801OM	
M	62.00 mm x 49.00 mm
	
7 6 1 2 6 3 5 0 8 9 2 1 8	



creole earrings	
KJ2HME080100	
S	21.00 mm
	
7 6 1 2 6 3 5 0 8 9 2 3 2	



ring	
KJ2HMR080105	
5	∅ 15.75 mm
	
7 6 1 2 6 3 5 0 8 8 7 0 9	
KJ2HMR080106	
6	∅ 16.55 mm
	
7 6 1 2 6 3 5 0 8 8 7 1 6	
KJ2HMR080107	
7	∅ 17.35 mm
	
7 6 1 2 6 3 5 0 8 8 7 2 3	
KJ2HMR080108	
8	∅ 18.15 mm
	
7 6 1 2 6 3 5 0 8 8 7 3 0	
KJ2HMR080109	
9	∅ 19.00 mm
	
7 6 1 2 6 3 5 0 8 9 1 8 8	

Calvin Klein

Calvin Klein intense



long pendant	
KJ2HPP280100	
S	800.00 mm adjustable at 500.00 mm / 40.00 mm x 43.00 mm
7 6 1 2 6 3 5 0 8 9 6 2 1	



closed bangle	
KJ2HPD2801XS	
XS	54.00 mm x 43.00 mm
7 6 1 2 6 3 5 0 8 9 5 9 1	
KJ2HPD2801OS	
S	58.00 mm x 46.00 mm
7 6 1 2 6 3 5 0 8 9 6 0 7	
KJ2HPD2801OM	
M	62.00 mm x 49.00 mm
7 6 1 2 6 3 5 0 8 9 6 1 4	



creole earrings	
KJ2HPE280100	
S	21.00 mm
7 6 1 2 6 3 5 0 8 9 6 3 8	



ring	
KJ2HPR280105	
5	∅ 15.75 mm
7 6 1 2 6 3 5 0 8 9 5 4 6	
KJ2HPR280106	
6	∅ 16.55 mm
7 6 1 2 6 3 5 0 8 9 5 5 3	
KJ2HPR280107	
7	∅ 17.35 mm
7 6 1 2 6 3 5 0 8 9 5 6 0	
KJ2HPR280108	
8	∅ 18.15 mm
7 6 1 2 6 3 5 0 8 9 5 7 7	
KJ2HPR280109	
9	∅ 19.00 mm
7 6 1 2 6 3 5 0 8 9 5 8 4	

Calvin Klein

Calvin Klein embrace



short pendant		7 6 1 2 6 3 5 0 9 0 5 8 0
KJ2KPP100100		
S	500.00 mm / 19.30 mm x 27.50 mm	



closed bangle		7 6 1 2 6 3 5 0 9 0 5 5 9
KJ2KPD1001XS		
XS	54.00 mm x 43.00 mm	
KJ2KPD10010S		7 6 1 2 6 3 5 0 9 0 5 6 6
S	58.00 mm x 46.00 mm	
KJ2KPD10010M		7 6 1 2 6 3 5 0 9 0 5 7 3
M	62.00 mm x 49.00 mm	



creole earrings		7 6 1 2 6 3 5 0 9 0 5 9 7
KJ2KPE100100		
S	11.40 mm x 22.50 mm	



ring		7 6 1 2 6 3 5 0 9 0 5 0 4
KJ2KPR100105		
5	∅ 15.75 mm	
KJ2KPR100106		7 6 1 2 6 3 5 0 9 0 5 1 1
6	∅ 16.55 mm	
KJ2KPR100107		7 6 1 2 6 3 5 0 9 0 5 2 8
7	∅ 17.35 mm	
KJ2KPR100108		7 6 1 2 6 3 5 0 9 0 5 3 5
8	∅ 18.15 mm	
KJ2KPR100109		7 6 1 2 6 3 5 0 9 0 5 4 2
9	∅ 19.00 mm	



Calvin Klein





short necklace	
KJ12GN010200	
S 470.00 mm	7 6 1 2 6 3 5 0 6 4 6 5 9

Calvin Klein wish











bracelet	
KJ12FB0101XS	
XS	7 6 1 2 6 3 5 0 5 8 7 0 2
KJ12FB0101OS	
S 206.00 mm	7 6 1 2 6 3 5 0 5 8 7 1 9
KJ12FB0101OM	
M 227.00 mm	7 6 1 2 6 3 5 0 5 8 7 2 6
KJ12FB0101OL	
L 247.00 mm	7 6 1 2 6 3 5 0 5 9 0 3 7



set of 3 round bangles	
KJ17AB0102XS	
XS Ø 60.00 mm	7 6 1 2 6 3 5 0 3 2 6 8 9
KJ17AB0102OS	
S Ø 65.00 mm	7 6 1 2 6 3 5 0 3 2 6 5 8
KJ17AB0102OM	
M Ø 70.00 mm	7 6 1 2 6 3 5 0 3 2 6 7 2



set of 3 rings	
KJ17ARO10105	
5 Ø 15.75 mm	7 6 1 2 6 3 5 0 2 8 2 5 5
KJ17ARO10106	
6 Ø 16.55 mm	7 6 1 2 6 3 5 0 2 8 2 6 2
KJ17ARO10107	
7 Ø 17.35 mm	7 6 1 2 6 3 5 0 2 8 2 7 9
KJ17ARO10108	
8 Ø 18.15 mm	7 6 1 2 6 3 5 0 2 8 2 9 3
KJ17ARO10109	
9 Ø 19.00 mm	7 6 1 2 6 3 5 0 2 8 3 0 9
KJ17ARO10110	
10 Ø 19.84 mm	7 6 1 2 6 3 5 0 3 2 0 5 4
KJ17ARO10111	
11 Ø 20.37 mm	7 6 1 2 6 3 5 0 3 2 0 6 1
KJ17ARO10112	
12 Ø 21.65 mm	7 6 1 2 6 3 5 0 3 2 0 7 8



Calvin Klein

Calvin Klein Jeans Astound



long necklace	
KJ81WN050100	
S 1,200.00 mm	7 6 1 2 6 3 5 0 7 4 3 5 1







set of 3 round bangles	
KJ81VWD0501XS	
XS Ø 60.00 mm	7 6 1 2 6 3 5 0 7 4 3 7 5
KJ81VWD0501OS	
S Ø 65.00 mm	7 6 1 2 6 3 5 0 7 4 3 8 2
KJ81VWD0501OM	
M Ø 70.00 mm	7 6 1 2 6 3 5 0 7 4 3 9 9



stud earrings	
KJ81WE050100	
S Ø 15.00 mm	7 6 1 2 6 3 5 0 7 4 4 3 6



set of 3 rings	
KJ81VR050105	
5 Ø 15.75 mm	7 6 1 2 6 3 5 0 7 4 2 5 2
KJ81VR050106	
6 Ø 16.55 mm	7 6 1 2 6 3 5 0 7 4 2 6 9
KJ81VR050107	
7 Ø 17.35 mm	7 6 1 2 6 3 5 0 7 4 2 7 6
KJ81VR050108	
8 Ø 18.15 mm	7 6 1 2 6 3 5 0 7 4 2 8 3
KJ81VR050109	
9 Ø 19.00 mm	7 6 1 2 6 3 5 0 7 4 2 9 0

Calvin Klein

Calvin Klein Jeans Astound



 black



long necklace	
KJ81BN050100	
S	1,200.00 mm



7 6 1 2 6 3 5 0 7 4 3 6 8







 black



set of 3 round bangles	
KJ81BD0501XS	
XS	Ø 60.00 mm
KJ81BD0501OS	
S	Ø 65.00 mm
KJ81BD0501OM	
M	Ø 70.00 mm

7 6 1 2 6 3 5 0 7 4 4 0 5
7 6 1 2 6 3 5 0 7 4 4 1 2
7 6 1 2 6 3 5 0 7 4 4 2 9





 black



stud earrings	
KJ81BE050100	
S	Ø 15.00 mm



7 6 1 2 6 3 5 0 7 4 4 4 3



 black



set of 3 rings	
KJ81BR050105	
5	Ø 15.75 mm
KJ81BR050106	
6	Ø 16.55 mm
KJ81BR050107	
7	Ø 17.35 mm
KJ81BR050108	
8	Ø 18.15 mm
KJ81BR050109	
9	Ø 19.00 mm

7 6 1 2 6 3 5 0 7 4 3 0 6
7 6 1 2 6 3 5 0 7 4 3 1 3
7 6 1 2 6 3 5 0 7 4 3 2 0
7 6 1 2 6 3 5 0 7 4 3 3 7
7 6 1 2 6 3 5 0 7 4 3 4 4

Calvin Klein

Calvin Klein embrace



short pendant		7 6 1 2 6 3 5 0 9 0 3 6 8
KJ2KMP000100		
S	500.00 mm / 19.30 mm x 27.50 mm	



closed bangle		7 6 1 2 6 3 5 0 9 0 3 3 7
KJ2KMD0001XS		
XS	54.00 mm x 43.00 mm	
KJ2KMD0001OS		7 6 1 2 6 3 5 0 9 0 3 4 4
S	58.00 mm x 46.00 mm	
KJ2KMD0001OM		7 6 1 2 6 3 5 0 9 0 3 5 1
M	62.00 mm x 49.00 mm	



creole earrings		7 6 1 2 6 3 5 0 9 0 3 7 5
KJ2KME000100		
S	11.40 mm x 22.50 mm	



ring		7 6 1 2 6 3 5 0 9 0 2 8 3
KJ2KMR000105		
5	∅ 15.75 mm	
KJ2KMR000106		7 6 1 2 6 3 5 0 9 0 2 9 0
6	∅ 16.55 mm	
KJ2KMR000107		7 6 1 2 6 3 5 0 9 0 3 0 6
7	∅ 17.35 mm	
KJ2KMR000108		7 6 1 2 6 3 5 0 9 0 3 1 3
8	∅ 18.15 mm	
KJ2KMR000109		7 6 1 2 6 3 5 0 9 0 3 2 0
9	∅ 19.00 mm	

Calvin Klein

Calvin Klein embrace



short pendant		7 6 1 2 6 3 5 0 9 0 4 8 1
KJ2KJP100100		
S	500.00 mm / 19.30 mm x 27.50 mm	



closed bangle		7 6 1 2 6 3 5 0 9 0 4 3 6
KJ2KJD1001XS		
XS	54.00 mm x 43.00 mm	
KJ2KJD10010S		7 6 1 2 6 3 5 0 9 0 4 6 7
S	58.00 mm x 46.00 mm	
KJ2KJD10010M		7 6 1 2 6 3 5 0 9 0 4 7 4
M	62.00 mm x 49.00 mm	



creole earrings		7 6 1 2 6 3 5 0 9 0 4 9 8
KJ2KJE100100		
S	11.40 mm x 22.50 mm	



ring		7 6 1 2 6 3 5 0 9 0 3 8 2
KJ2KJR100105		
5	∅ 15.75 mm	
KJ2KJR100106		7 6 1 2 6 3 5 0 9 0 3 9 9
6	∅ 16.55 mm	
KJ2KJR100107		7 6 1 2 6 3 5 0 9 0 4 0 5
7	∅ 17.35 mm	
KJ2KJR100108		7 6 1 2 6 3 5 0 9 0 4 1 2
8	∅ 18.15 mm	
KJ2KJR100109		7 6 1 2 6 3 5 0 9 0 4 2 9
9	∅ 19.00 mm	

Calvin Klein

CALVIN KLEIN JEANS CORE COLLECTION JEWELRY

Calvin Klein Jeans Astound (KJ81)	146
Calvin Klein Jeans Waves (KJ17)	148



Calvin Klein

Calvin Klein Jeans Astound



long necklace	
KJ81WN050100	
S 1,200.00 mm	7 6 1 2 6 3 5 0 7 4 3 5 1





set of 3 round bangles	
KJ81VWD0501XS	
XS Ø 60.00 mm	7 6 1 2 6 3 5 0 7 4 3 7 5
KJ81VWD0501OS	
S Ø 65.00 mm	7 6 1 2 6 3 5 0 7 4 3 8 2
KJ81VWD0501OM	
M Ø 70.00 mm	7 6 1 2 6 3 5 0 7 4 3 9 9



stud earrings	
KJ81WE050100	
S Ø 15.00 mm	7 6 1 2 6 3 5 0 7 4 4 3 6



set of 3 rings	
KJ81VR050105	
5 Ø 15.75 mm	7 6 1 2 6 3 5 0 7 4 2 5 2
KJ81VR050106	
6 Ø 16.55 mm	7 6 1 2 6 3 5 0 7 4 2 6 9
KJ81VR050107	
7 Ø 17.35 mm	7 6 1 2 6 3 5 0 7 4 2 7 6
KJ81VR050108	
8 Ø 18.15 mm	7 6 1 2 6 3 5 0 7 4 2 8 3
KJ81VR050109	
9 Ø 19.00 mm	7 6 1 2 6 3 5 0 7 4 2 9 0

Calvin Klein

Calvin Klein Jeans Astound



 black
 

long necklace	
KJ81BN050100	
S	1,200.00 mm



7 6 1 2 6 3 5 0 7 4 3 6 8





 black
 

set of 3 round bangles	
KJ81BD0501XS	
XS	∅ 60.00 mm
KJ81BD0501OS	
S	∅ 65.00 mm
KJ81BD0501OM	
M	∅ 70.00 mm

7 6 1 2 6 3 5 0 7 4 4 0 5
7 6 1 2 6 3 5 0 7 4 4 1 2
7 6 1 2 6 3 5 0 7 4 4 2 9



 black
 

stud earrings	
KJ81BE050100	
S	∅ 15.00 mm



7 6 1 2 6 3 5 0 7 4 4 4 3



 black
 



set of 3 rings	
KJ81BR050105	
5	∅ 15.75 mm
KJ81BR050106	
6	∅ 16.55 mm
KJ81BR050107	
7	∅ 17.35 mm
KJ81BR050108	
8	∅ 18.15 mm
KJ81BR050109	
9	∅ 19.00 mm

7 6 1 2 6 3 5 0 7 4 3 0 6
7 6 1 2 6 3 5 0 7 4 3 1 3
7 6 1 2 6 3 5 0 7 4 3 2 0
7 6 1 2 6 3 5 0 7 4 3 3 7
7 6 1 2 6 3 5 0 7 4 3 4 4









Calvin Klein

Calvin Klein Jeans Waves



set of 3 round bangles	
KJ17AB0102XS	
XS Ø 60.00 mm	7 6 1 2 6 3 5 0 3 2 6 8 9
KJ17AB0102OS	
S Ø 65.00 mm	7 6 1 2 6 3 5 0 3 2 6 5 8
KJ17AB0102OM	
M Ø 70.00 mm	7 6 1 2 6 3 5 0 3 2 6 7 2



set of 3 rings	
KJ17ARO10105	
5 Ø 15.75 mm	7 6 1 2 6 3 5 0 2 8 2 5 5
KJ17ARO10106	
6 Ø 16.55 mm	7 6 1 2 6 3 5 0 2 8 2 6 2
KJ17ARO10107	
7 Ø 17.35 mm	7 6 1 2 6 3 5 0 2 8 2 7 9
KJ17ARO10108	
8 Ø 18.15 mm	7 6 1 2 6 3 5 0 2 8 2 9 3
KJ17ARO10109	
9 Ø 19.00 mm	7 6 1 2 6 3 5 0 2 8 3 0 9
KJ17ARO10110	
10 Ø 19.84 mm	7 6 1 2 6 3 5 0 3 2 0 5 4
KJ17ARO10111	
11 Ø 20.37 mm	7 6 1 2 6 3 5 0 3 2 0 6 1
KJ17ARO10112	
12 Ø 21.65 mm	7 6 1 2 6 3 5 0 3 2 0 7 8

Calvin Klein

Calvin Klein

KARIM SADLI, PHOTOGRAPHER

Born in Paris, Karim Sadli grew up in a rich multicultural environment that fostered his passion for photography from an early age. After studying literature and philosophy at the Sorbonne, Sadli relocated to London for five years to pursue his formal studies in photography at the London College of Communication. Sadli's work showcases his instinctual ability to shoot both fashion and portraiture to consistently modern and elegant effect. His minimalist aesthetic and sophisticated

use of lighting bring into sharp relief the natural beauty of his subjects. Sadli's photographs have been featured in *Vogue Paris*, *British Vogue*, *American Vogue*, *W Magazine*, *i-D*, *T Magazine*, *The Gentlewoman* and *Fantastic Man*. His advertising clients include Dior, Jil Sander, Chanel, Givenchy, Balmain, Maje, Sandro, Akris, Lacoste, Trussardi, Yves Saint Laurent and Isabel Marant.



Calvin Klein

PERIOD 1

CALVIN KLEIN SENSES

Spirited. Substantial. **Calvin Klein senses.** The dualities of everyday modern life inspired the unique silhouette of Calvin Klein senses. The bangle watch is made up of a sleek, twisted form offered in either solid stainless steel, PVD yellow and pink

gold, or two beautiful bicolor styles that mix stainless steel with PVD yellow or pink gold.



Calvin Klein

PERIOD 1

CALVIN KLEIN ALLIANCE

Lustrous. Enduring. **Calvin Klein alliance.** A linear construction is rendered in polished stainless steel for a striking and graphic look. Inspired by urban architecture, Calvin Klein alliance marries sapphire glass, polished metals and mother of pearl for a bright effect. For men, Calvin

Klein alliance is available in both a chronograph and traditional watch design, paired with a silver or black dial and a polished stainless steel bracelet and case.



Calvin Klein

PERIOD 1

CALVIN KLEIN BREATHE

Elegance. Motion. **Calvin Klein breathe.** Polished stainless steel and PVD pink gold come together to create a uniquely layered elliptical form inspired by sound waves. This highly dimensional offering includes a choker and earrings,

ring (sizes 6, 7 and 8) and closed bangle – available in sizes extra small, small and medium.

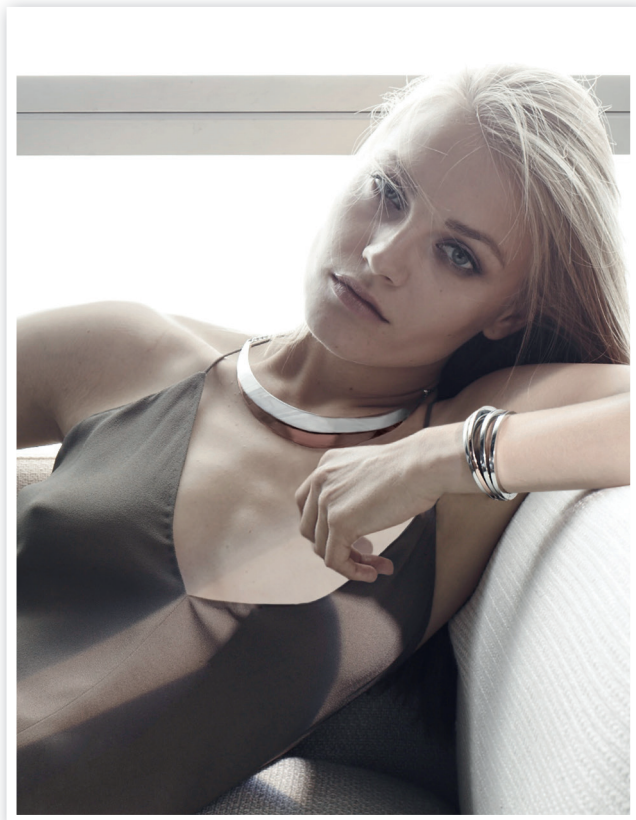

Calvin Klein

PERIOD 2

CALVIN KLEIN SPELLBOUND

Watch:

Natural. Inspired. Calvin Klein spellbound. Ancient history reimagined for the modern world. Calvin Klein spellbound brings together python

embossed leather in rich mineral-inspired tones with a bold silhouette for an impactful look.



Calvin Klein

PERIOD 2

CALVIN KLEIN SPELLBOUND

Jewelry:
Sensual. Captivating. Calvin Klein spellbound. Soft embossed python leather and hard metal come together to create this seductively sleek jewelry set.



Calvin Klein

PERIOD 2

CALVIN KLEIN EARTH

Bold. Technical. Calvin Klein earth. This urban and refined timepiece features a substantial brushed stainless steel or PVD black case for an impression of enduring masculinity and makes it the perfect accent for a casual chic

weekend look. Needless embellishment is cast aside in favor of honesty through smart simplification of form.



Calvin Klein

DISPLAYS AND ELEMENTS LARGE DISPLAY

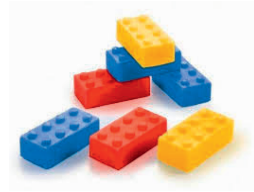

K801.112.103
backpanel height 280 mm

or



K801.112.104
backpanel height 420 mm

or



K801.112.108
backpanel height 600 mm

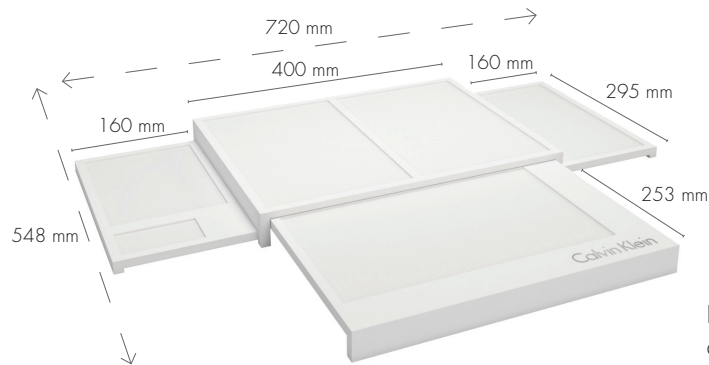

Backpanels are also available alone
280 = K801.112.325
420 = K801.112.326
600 = K801.112.011

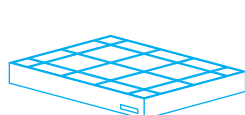

4x C1
180 x 135.5 x 20 mm

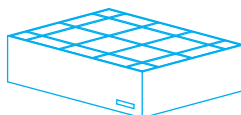

2x C2
180 x 135.5 x 45 mm

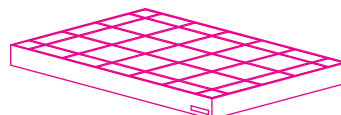

2x D
180 x 269 x 20 mm



1 x sisal block
90 x 90 x 20 mm



2 x square block
45 x 45 x 20 mm



2 x square block
45 x 45 x 45 mm



2 x square block
45 x 45 x 60 mm

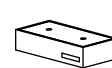

2 x double square block
90 x 45 x 20 mm



25 x c-ring
vertical women
Ø 55/65 mm

Ø 55 coming soon

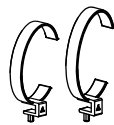

25 x c-ring
vertical men
Ø 85/95 mm

Ø 85 coming soon



4 x c-ring
horizontal

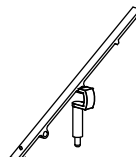

4 x c-ring
tobogan



45 x t-bar
10 mm



25 x t-bar
40 mm

Calvin Klein

DISPLAYS AND ELEMENTS LARGE DISPLAY

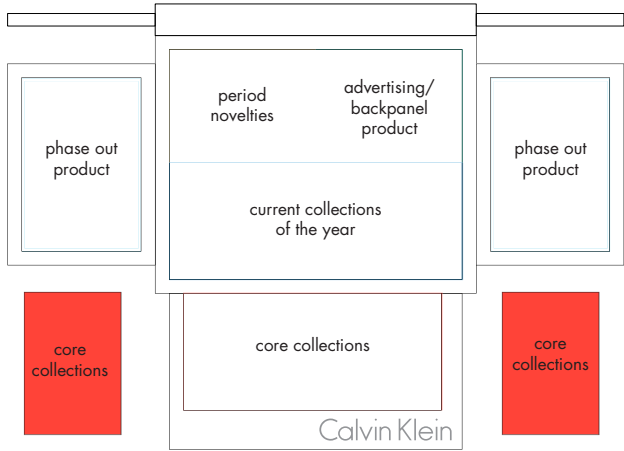
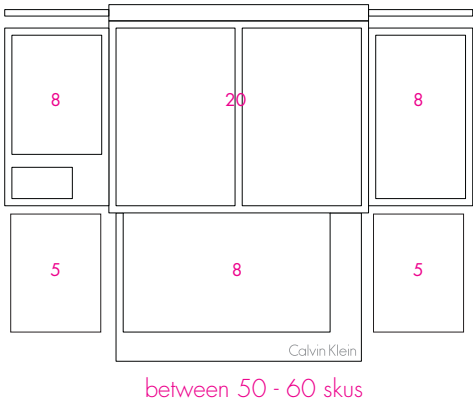
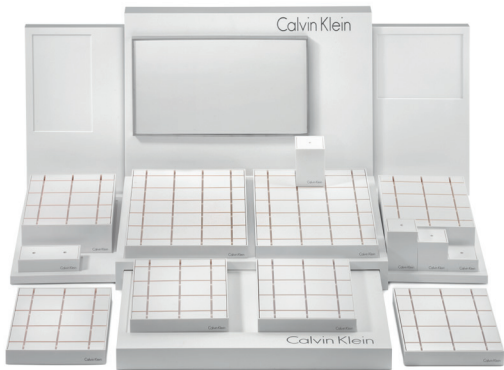

do not put products directly on the base

do not mix watches and jewelry

create a clear separation between men and women

Calvin Klein

DISPLAYS AND ELEMENTS SMALL DISPLAY

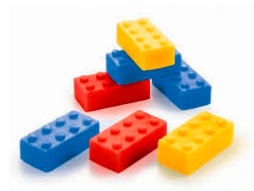

K801.112.101
backpanel height 280 mm

or



K801.112.102
backpanel height 420 mm

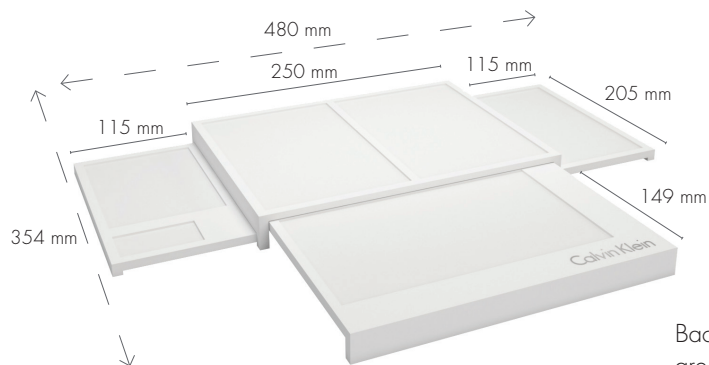

Backpanels 280 and 420
are also available alone
280 = K801.112.323
420 = K801.112.324

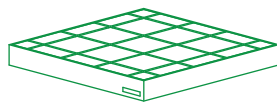

1x A1
180 x 180 x 20 mm



3x B1
90 x 135.50 x 20 mm

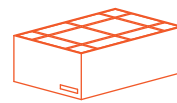

2x B2
90 x 135.50 x 45 mm



1 x sisal block
90 x 90 x 20 mm



1 x square block
45 x 45 x 20 mm



1 x square block
45 x 45 x 45 mm



1 x square block
45 x 45 x 60 mm



1 x double square block
90 x 45 x 20 mm



15 x c-ring
vertical women
Ø 55/65 mm

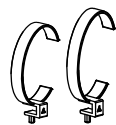

15 x c-ring
vertical men
Ø 85/95 mm



2 x c-ring
horizontal

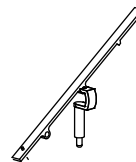

2 x c-ring
tobogan



20 x t-bar
10 mm



20 x t-bar
40 mm

Calvin Klein

DISPLAYS AND ELEMENTS SMALL DISPLAY

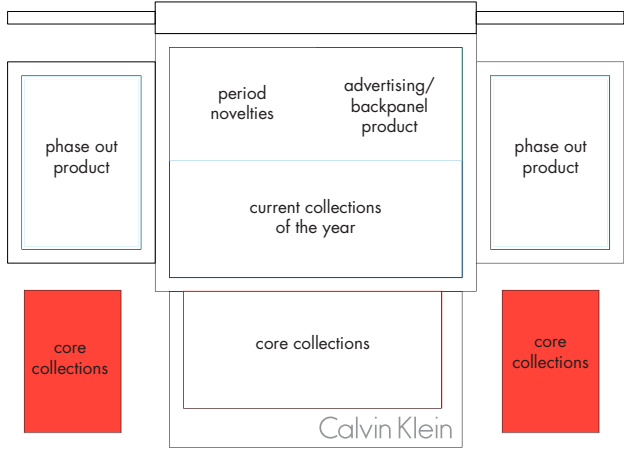
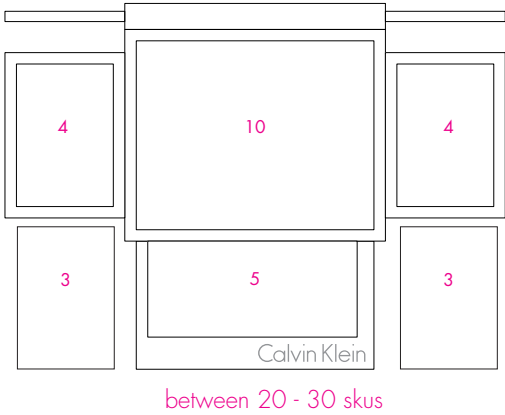

do not put products directly on the base

do not mix watches and jewelry

create a clear separation between men and women

DISPLAYS AND ELEMENTS COUNTER DISPLAY

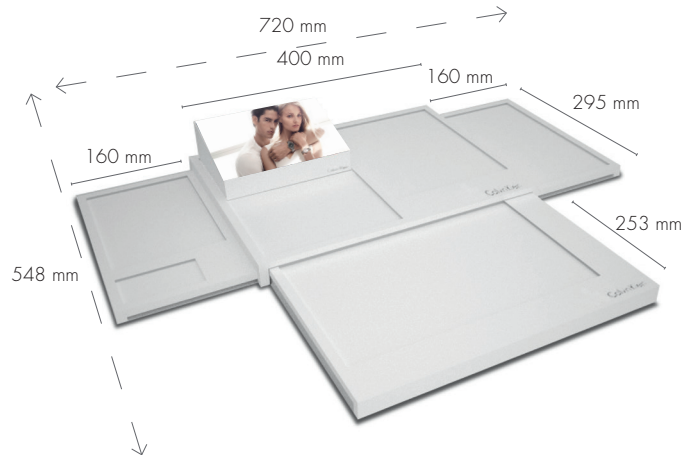
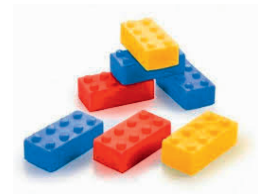

K801.112.107

Counter visual block is also available alone
K801.114.002

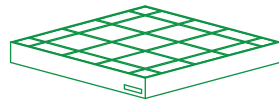

1x A1
180 x 180 x 20 mm

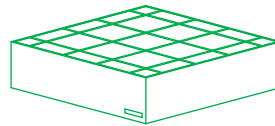

1x A2
180 x 180 x 45 mm

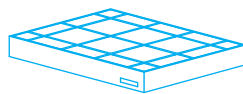

3x C1
180 x 135.5 x 20 mm

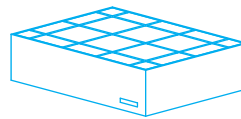

3x C2
180 x 135.5 x 45 mm

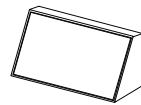
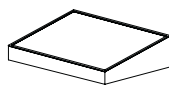

1x holder
can be placed from 2 different ways (down and up)



2 x square block
45 x 45 x 20 mm



2 x square block
45 x 45 x 45 mm



2 x square block
45 x 45 x 60 mm



2 x double square block
90 x 45 x 20 mm



25 x c-ring
vertical women
Ø 55/65 mm

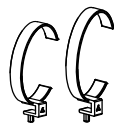

25 x c-ring
vertical men
Ø 85/95 mm



4 x c-ring
horizontal

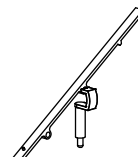

4 x c-ring
tobogan



45 x tbar
10 mm



25 x tbar
40 mm

Calvin Klein

DISPLAYS AND ELEMENTS COUNTER DISPLAY

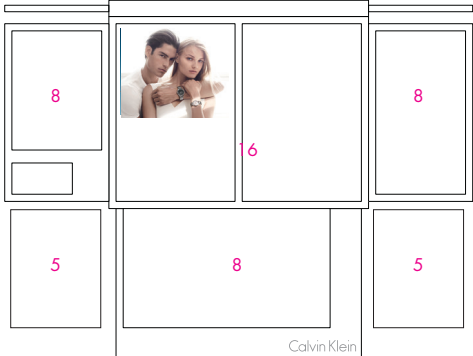

between 40 - 50 skus



do not put products directly on the base

do not mix watches and jewelry

create a clear separation between men and women

DISPLAYS AND ELEMENTS JEWELRY SET

KJ801.112.008 jewelry set is composed of:

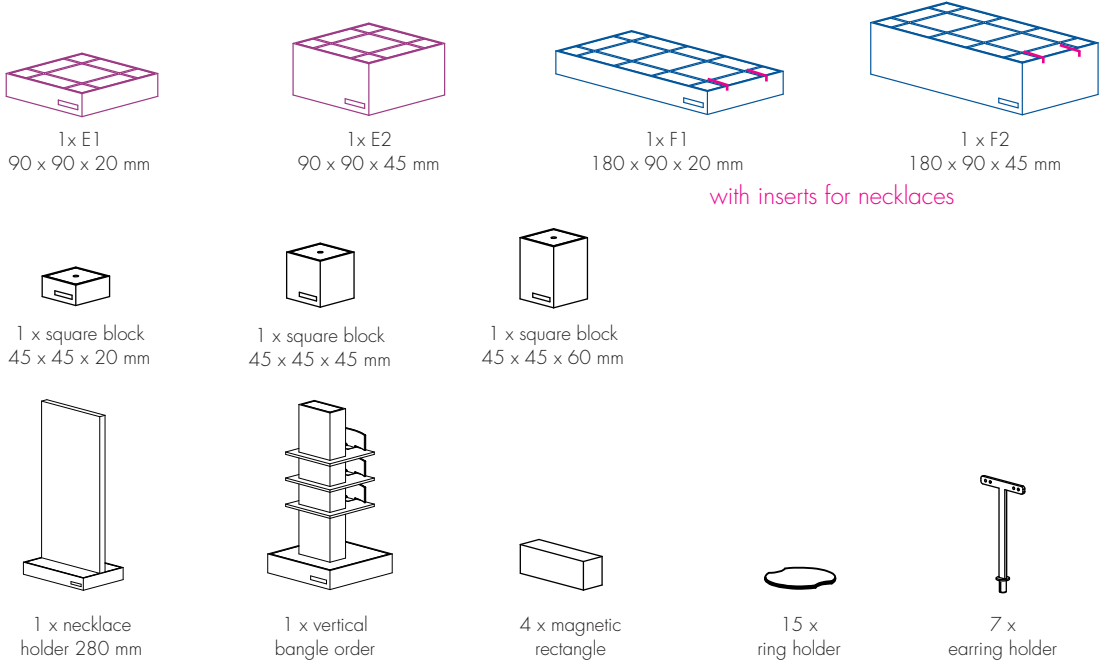

additional pieces can be ordered separately

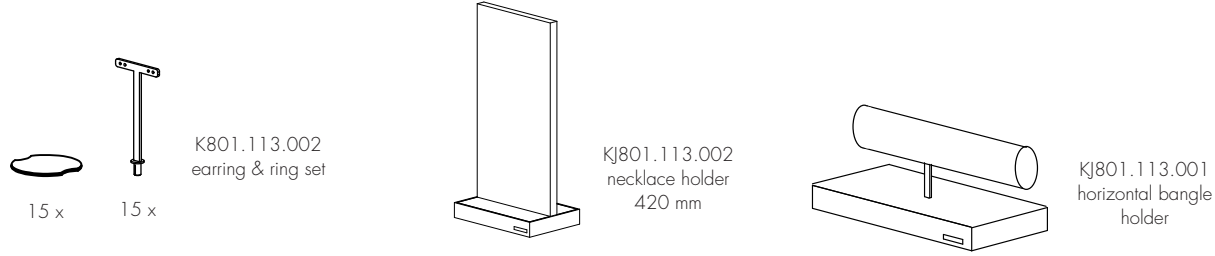

Calvin Klein

DISPLAYS AND ELEMENTS TOWER SET

K801.112.009

tower elements set

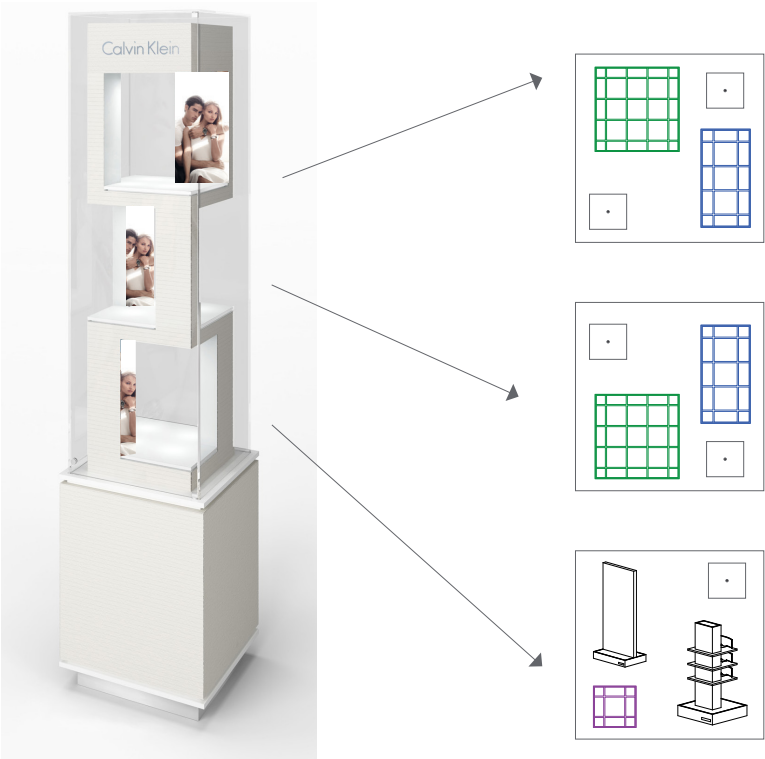

tower set is composed of:

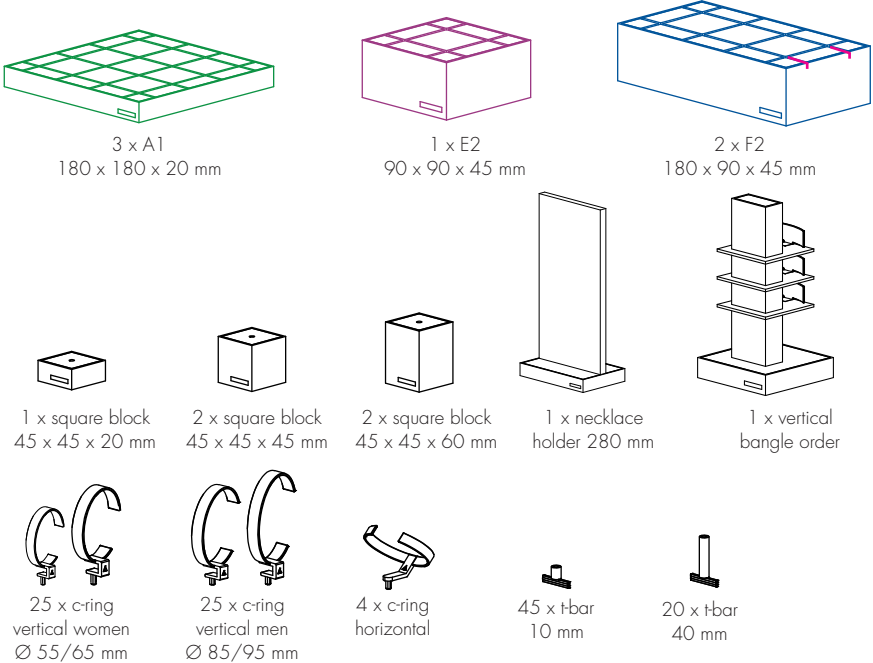

DISPLAYS AND ELEMENTS HOW TO USE THE ELEMENTS

WATCHES

display the watches on the vertical and horizontal rails

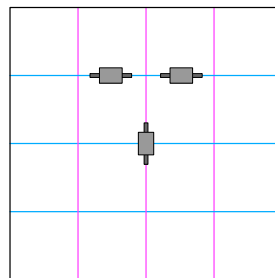

FLIP THE ELEMENT!
it is reversible

JEWELRY

display the jewelry on the flat side of the grid



Calvin Klein

DISPLAYS AND ELEMENTS HOW TO DISPLAY JEWELS

necklace



magnetic
rectangle



necklace holder
420 mm



necklace holder
280 mm



necklace holder
200 mm



grid side jewelry



ring



square block



ring holder



grid side jewelry

bangle and bracelet

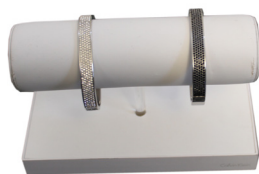

horizontal
bangle holder



vertical
bangle holder



square block
with crings



grid side jewelry

earrings



square block
(display 2-4 earrings)

Calvin Klein

MERCHANDISING IN CALVIN KLEIN FURNITURE TELL SOME STORIES



COLOR CONCEPT
Khaki

COLOR CONCEPT
black and white

MATERIAL CONCEPT
Pink PVD





MATERIAL CONCEPT
Swarovski

MATERIAL CONCEPT
Silicon

NOVELTIES STORY
Calvin Klein edge

Calvin Klein

MERCHANDISING IN CALVIN KLEIN FURNITURE DISPLAY ALLOCATION

-  counter display
-  large display, backpanel 280 mm
-  small display, backpanel 280 mm / or without backpanel (towers)
-  separate elements (section to tell some stories) to communicate novelties recently launched
-  tower set

TOWER ELEMENTS



U1

U2

U1B

COUNTER ELEMENTS



U3

U4

U5

Calvin Klein

MERCHANDISING IN CALVIN KLEIN FURNITURE DISPLAY ALLOCATION

FREESTANDING FURNITURE UNITS

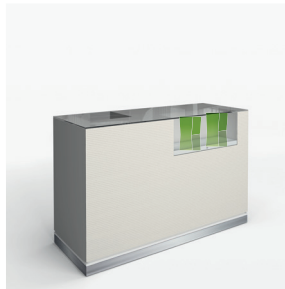

CASH WRAP



WINDOW VITRINE
SMALL



WINDOW VITRINE
SMALL

BACKWALL ELEMENTS



SEASONAL DISPLAY NICHE



SINGLE WALL VITRINE



GRID WALL

Calvin Klein

MERCHANDISING IN CALVIN KLEIN FURNITURE DISPLAY ALLOCATION

GONDOLA ELEMENTS



JEWELRY



WATCHES



1.0M



1.5M



1.5M



2.0M



2.0M



2.0M

Calvin Klein

MERCHANDISING IN CALVIN KLEIN FURNITURE DISPLAY ALLOCATION



2.5M



2.5M



3.0M



3.0M



3.0M



4.0M

Calvin Klein

MERCHANDISING IN CALVIN KLEIN FURNITURE JEWELRY GONDOLAS



between 40 - 50 jewelry



you can display 8 rings on the small box which are mainly dedicated for the novelties.



you can display 36 rings on the ring trays.

we recommend to display the products by colors (SST, PVD pink, black ...)

Calvin Klein

MERCHANDISING IN CALVIN KLEIN FURNITURE WATCHES GONDOLAS



between 50 - 70 watches



on the corner windows please use
separate elements (grids, block, ...) or
to highlight special concepts.

Calvin Klein

MERCHANDISING IN CALVIN KLEIN FURNITURE DISPLAY PER MODEL TYPE



create a clear separation between watches and jewelry and, between men and women



men watches



ladies watches



jewelry



the only exception to mix watches and jewelry is when there is a real concept.
You can make an highlight of this concept in some visible points.

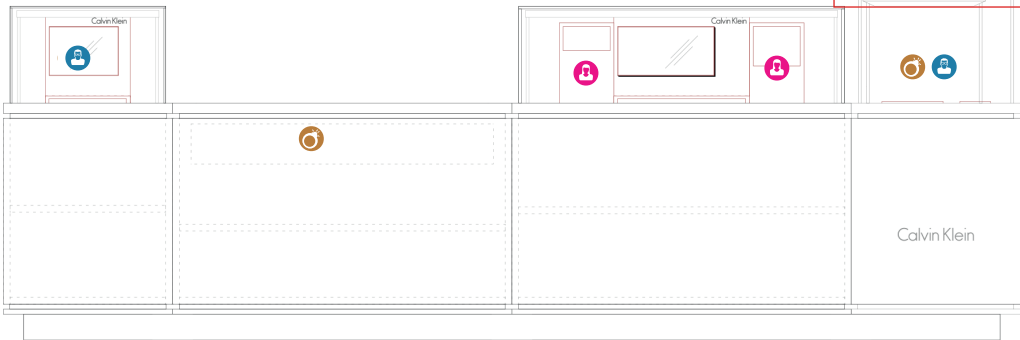
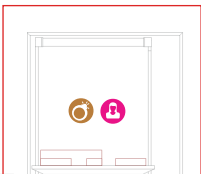

Calvin Klein

MERCHANDISING IN CALVIN KLEIN FURNITURE NOVELTIES DISPLAY

highlight novelties at the center /or at the top

★ novelties

novelties highlighted
at the center

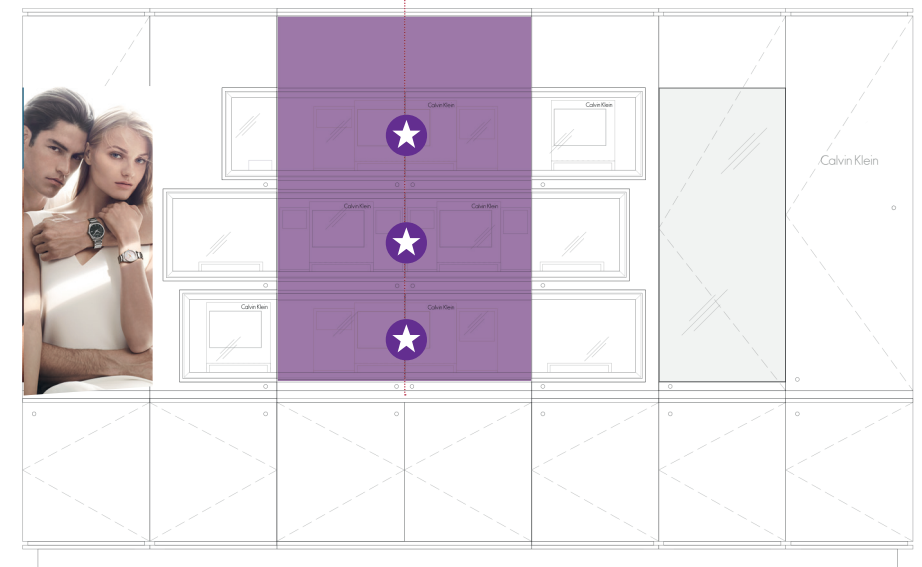

novelties + special concepts
highlighted on the top

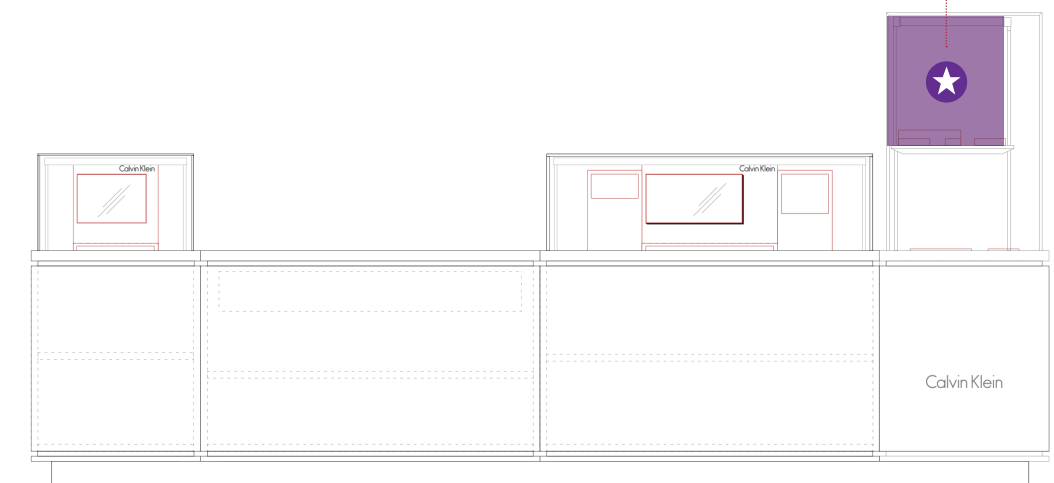

Calvin Klein

MERCHANDISING IN CALVIN KLEIN FURNITURE NOVELTIES DISPLAY

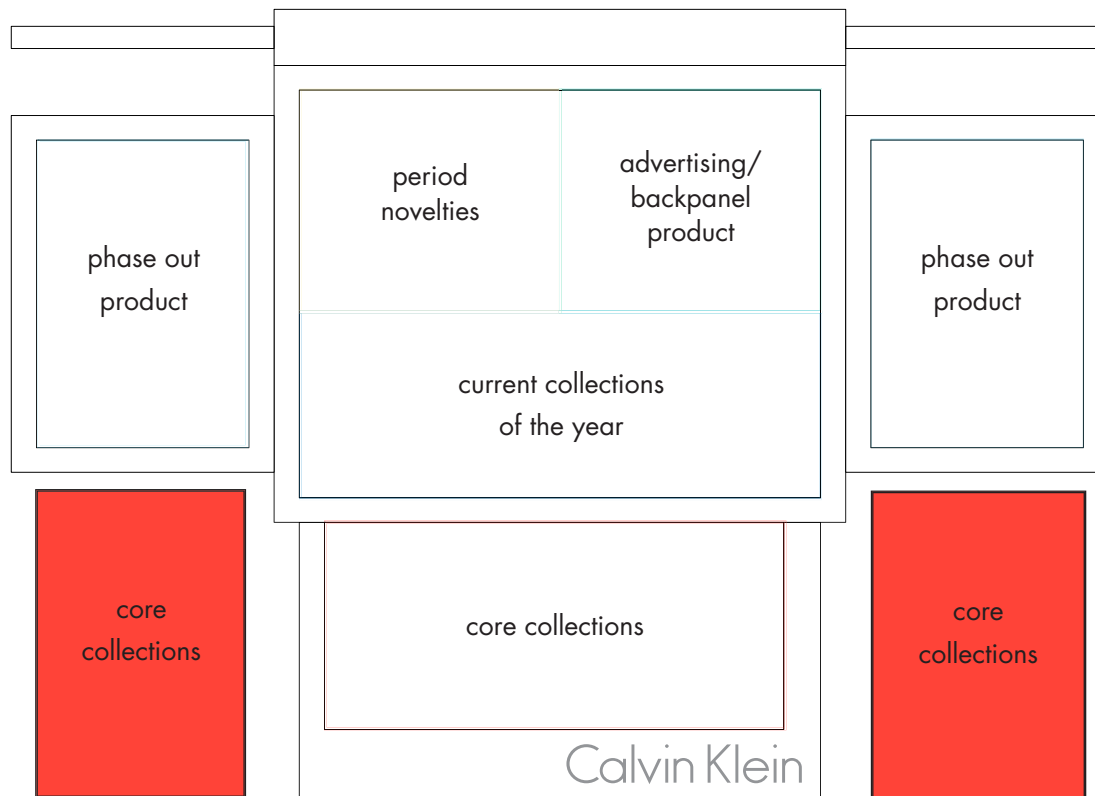

important reminder:

- do not display watches and jewelry together
- do not display men and women watches mixed together

only exception is for a real «concept», a line including watches and jewelry (ex: Calvin Klein body)

The clue to a good merchandising is to highlight the new collection.

The customer should directly be able to see which are the new collection:

- by grouping them
- by identifying them (name plates, highlighter, seasonal decoration)

Calvin Klein

GENERAL MECHANDISING RULES FOR BOUTIQUE, SIS AND WHOLESALE

ENVIRONMENT

- select carefully an adapted environment in the POS

DEMARCATATE YOURSELF!

- always separate Calvin Klein from other brands and do not use elements of any other brand

BE VISIBLE!

- whenever possible use the large display with the tall back panel

LESS IS MORE

- use space to maximize visual effect

BE CAREFUL WITH CLEANLINESS!

- Clean and dust your presentation constantly and take care of the products

NOVELTIES

identification of the novelties

- by grouping them
- by using name plates, highlighter, special decoration

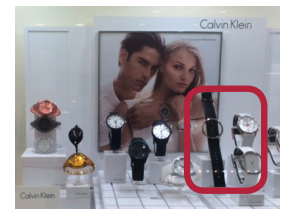

PRODUCTS

- group products by family with a representative number
- all product must be visible, facing the customer
- be consistent with colors



VISUAL

- the highlighted product needs to correspond with the background visual

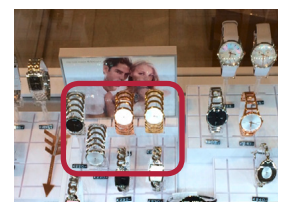

- use visuals corresponding to actual communication campaign



Calvin Klein

GENERAL MECHANDISING RULES FOR BOUTIQUE, SIS AND WHOLESALE



WATCHES AND JEWELRY

- do not mix watches and jewelry except for a special concept
- display men & women watches together only if you have only 1 display in the POS. even with 1 display create a clear separation between genders

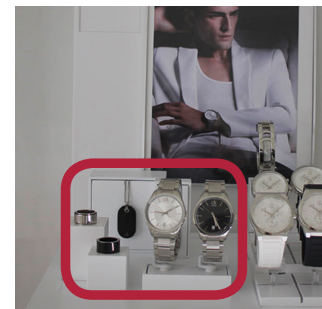

JEWELRY

- do not put a piece of jewelry into another piece
- each piece must be presented independently



PRICE TAG

- the string should be carefully wound and the tag bloqued under the c-ring



LOGO

- the logo must be readable from the bottom to the top



Calvin Klein

MATERIAL SPECIFICATIONS

STAINLESS STEEL

A high quality, non-oxidizing, hypoallergenic stainless steel 316L is used for Calvin Klein jewelry.

ENAMEL GRIP COATING

A rigid colored polymer hardened by thermal treatment.

GOLD PLATING/PVD

Gold Plating is an electrochemical process that deposits a gold metallic layer by electrolysis of a gold solution.

An alternative to gold plating, PVD (Physical Vapor Deposit) is a process whereby a base metal is coated with coloured titanium ceramic.

DIAMONDS

A brief review of the four key criteria used in assessing diamonds, with reference to those used for Calvin Klein jewelry:

CUT

Diamonds are cut and faceted to precise parameters to determine their shape, proportion, polish and brilliance.

The diamonds used for Calvin Klein jewelry are full-cut brilliant diamonds (there are 32 facets on the upper part of the stone and 24 facets on the lower part). A good cut is recognized by its light-handling qualities – maximum brilliance and dispersion of light through the diamond.

COLOUR

The colour of diamonds varies from colourless (highest quality) to many shades of yellow (less rare). The various gradations, from exceptional white to yellowish, are barely perceptible to the naked eye.

Wesselton (white) diamonds are used for Calvin Klein jewelry.

CLARITY

Diamonds are a natural substance, and no two diamonds are exactly alike. Nature signs each creation with telltale inclusions, or internal flaws. The clarity refers to the degree to which a diamond is free of such inclusions. The size and position of inclusions affect the clarity of a stone according to how visible they are at 10x.

The diamonds used for Calvin Klein jewelry are graded VS (very small inclusions) to SI (small inclusions).

CARAT WEIGHT

The weight – and therefore the size – of a diamond is measured and expressed in carats. One carat equals 0.2 grams.

The word “carat” comes from the ancient practice in India (where diamonds were first discovered and traded) of measuring diamond weights with the one thing in nature that is both small and the most consistent in weight – the carob seed. Thus the name “carat” evolved in the English language, which is still equivalent to approximately the weight of one carob bean.

The diamonds used for Calvin Klein jewelry range in weight from 0.005 to 0.155 carats.

SETTING

The setting of jewels in steel prepared mechanically makes it possible to produce large editions with perfect regularity and impeccable quality. It represents an alliance between the artisan and high technology.

Calvin Klein

MATERIAL SPECIFICATIONS

The jewel is first machined on a milling machine to bore residences perfectly adapted to diamonds diameter and prepare small pyramids (corns) which will be pushed back on the stone to set it.

The setter at his working place, poses the stones one by one then pushes down the corns one by one on the stone to finally "pearl" them to give them the round and shiny appearance of a pearl. Since steel is much harder than gold, the setter's work is more delicate and difficult. The setter must therefore perform the work using a great deal of force.

GLASS

Glass is coloured either by pigmentation or by coating the lower transparent surface.

Its specific structure enables high resistance to wear and corrosion.

Other materials such as leather, silk finish strings, lacquer or satin are occasionally used in ck jewelry collections.

CARE

Stainless steel Calvin Klein jewels can be polished to restore their original lustre. In order to guarantee its longevity, we nevertheless recommend that you handle it with great care and avoid hitting tinted glass against hard surfaces.

Please note that accessories like leather and textile bracelets can wear prematurely if regularly exposed to water.

Calvin Klein

Calvin Klein watch uses exclusively ETA SWISS MADE MECHANISMS

Generally, our watches are supplied with highly precise and battery powered quartz mechanisms.

Like every electronic device, the battery powered quartz mechanism requires very little maintenance other than periodic battery replacement.

Some limited-edition watches with mechanical movements have also been released on the market.

CASE

The case is the most prominent design feature that determines the design characteristics and the shape of a watch. Calvin Klein watch cases have very distinctive outlines and are immediately recognisable. They are exclusively made of hypoallergenic 316L stainless steel

CASEBACK

In order to better identify the product, the main characteristics of Calvin Klein watches are engraved on the caseback. These details include the Swiss Made mark, Calvin Klein logo, watch model number, the watch case water-resistance, etc.

Depending on watch design and model, the caseback may be locked by simply pressing it in or fixed with screws.

CROWN

The crown, or setting knob, usually at 3 o'clock, is used to change the watch time and/or day and date as well as wind up a mechanical watch movement. It is branded with a discreet "ck" icon.

DIALS AND HANDS

Dials and hands can be considered as the face of the timepiece.

This prominent decorative part of the watch is systematically identified with a swiss made mark and Calvin Klein logo. Calvin Klein watch offers a wide choice of dials in many different colours and designs. Recently diamond-set dials have been introduced to the ck watch collection.

Some hands are manufactured with SuperLuminova, a substance that absorbs energy when exposed to light and then glows in the dark.

BRACELET

The bangle bracelets on Calvin Klein watches are made of stainless steel. For certain models PVD surface treatment is also used as an alternative to gold plating.

STRAPS

Calvin Klein watchstraps are primarily made of calf leather. Calvin Klein straps have traditional pin or deployment buckles.

Calvin Klein watch bracelets and straps are very unique in design and normally carry discreet branding of the Calvin Klein logo on the clasp, the buckle and the leather inlay.

Calvin Klein

WATER-RESISTANCE

The majority of Calvin Klein watches are water-resistant up to 3 bar, occasionally 5 or 10 bar.

The indication of water-resistance means the watch does not require special attention when used in humid conditions. This convenient technical solution prevents perspiration and dust from entering the watchcase.

The standard value of water-resistance may not comply with an absolute immersion depth. Equivalent pressure may be exerted when diving into a swimming pool or taking a shower.

Water-resistance is not permanent. Age, salt, water, sand, dust, perspiration, temperature and many other factors may alter the characteristics of the components that ensure a watch's water-resistance.

Systematic seal replacement and a water-resistance test are required at each battery replacement or before significant periods of regular swimming. Only watches engraved with the words "water-resistant" on the caseback are protected from water entering the case.

IMPORTANT

A water-resistant watch is not a diving watch; therefore, in no case should it be used as a diving instrument.

Accessories like leather and textile straps can wear prematurely if regularly exposed to water.

We suggest choosing metal bracelets for customers planning to wear their watch for swimming.

Calvin Klein

REMOVING/REPLACING A BRACELET

The best position to use the spring bar tool is perpendicular to the end link spring bars. Remove the spring bar by pressing down (use the spring bar shoulder) one end with the "spring bar tool" fork (as shown in figure #1). Then to extract the spring bar, just apply an upward pressure to the bracelet or end link; this will help you to push the end link out of its position between the lugs. Proceed in the same manner for the other spring bar end (as shown in figure #2).

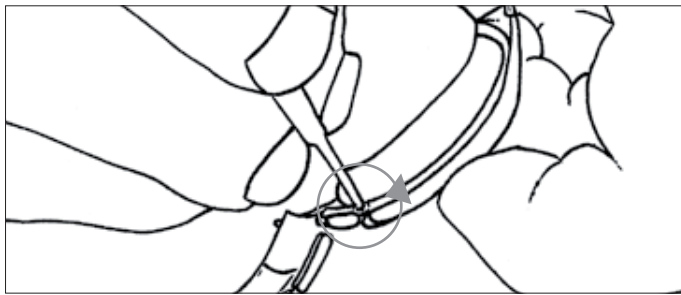

figure #1

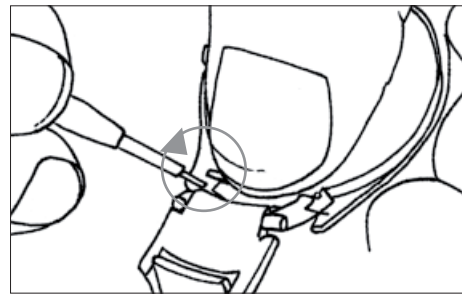

figure #2

To reattach the bracelet, first position the end link between the lugs; using the "spring bar tool" fork, push one spring bar end into its specific hole. Next, press down on the opposite end and fit it into its hole. Check the bracelet is secure by pulling firmly to make sure that both end link spring bars and the clasp spring bar are firmly attached.

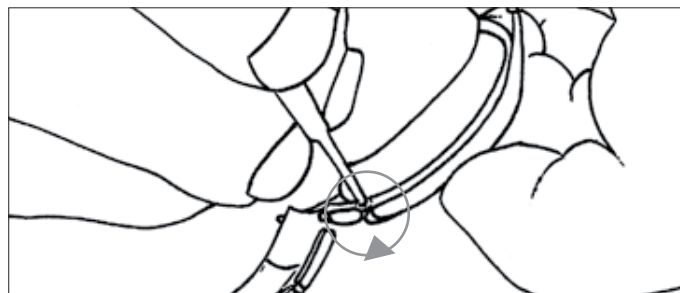

figure #3

To attach a new bracelet, position the end link between lugs, place one end of the spring bar in the desired hole, then press down on the upper end and insert it into its hole.

Calvin Klein

REMOVING LINKS IN A "PIN AND TUBE" BRACELET

Using the pin pusher, remove the pin securing the link and pull the pin completely out of the bracelet link. Do not lose the tube when disassembling the links. To reassemble the links, re-insert the tube, assemble the links and then drive the pin in. You should feel and hear a little "click" when the pin slots into position.

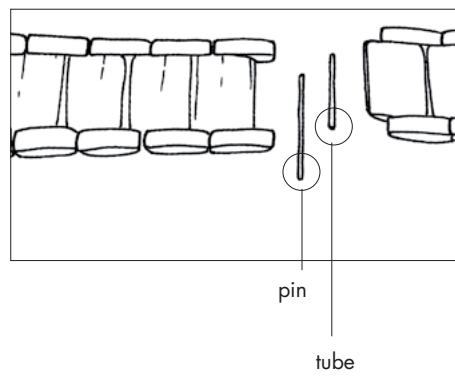
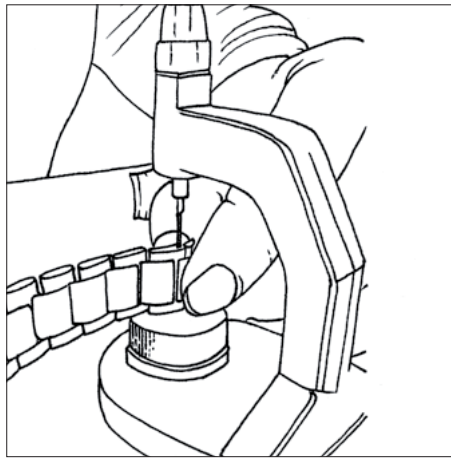

Calvin Klein

REMOVING LINKS IN A "SCREW" BRACELET

Using the correct sized screwdriver, undo the screw anticlockwise until it comes free. Separate the links and shorten or lengthen the bracelet as desired. NB: Do not use too much force and pressure when replacing the screw as this could damage the screw head or thread.

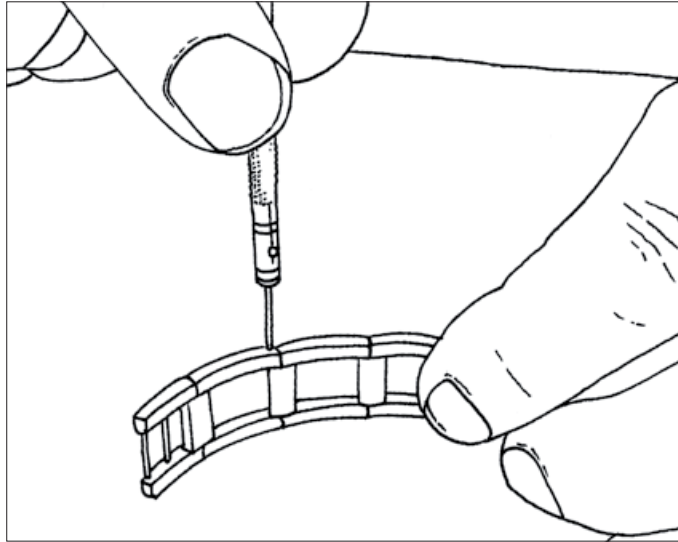

Calvin Klein

RING SIZES AND RIGIDE BANGLE STANDARD

ck sizes	⊙	EU sizes	⊙
5	15.75 mm	49	15.60 mm
		50	15.92 mm
6	16.55 mm	51	16.23 mm
		52	16.55 mm
*	*	53	16.87 mm
7	17.35 mm	54	17.19 mm
		55	17.71 mm
*	*	56	17.83 mm
8	18.15 mm	57	18.14 mm
		58	18.46 mm
9	19.00 mm	59	18.78 mm
		60	19.10 mm
*	*	61	19.42 mm
10	19.84 mm	62	19.74 mm
		63	20.05 mm
11	20.37 mm	64	20.37 mm
		65	20.69 mm
12	21.65 mm	67	21.30 mm
		68	21.60 mm

* as the choice of size depends on the shape of the ring, please ask your customer to try the ring on.

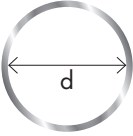
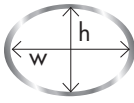
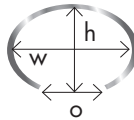
	round bangle	closed bangle	open bangle
			
sizes / dimensions	d	w x h	w x h/o
XS	60 mm	54 x 43 mm	54 x43/27 mm
S	65 mm	58 x 46 mm	58 x46/27 mm
M	70 mm	62 x 49 mm	62 x49/30 mm
L	-	65 x 51 mm	65 x 51/32 mm
XL	-	68 x 54 mm	68 x 54/35 mm